

Visit nipponpulse.com to download 3D CAD drawings and 2D prints of this motor.

Electrical Specs	S250D		S250T		S250Q		
	S250D	S250D 1S	S250T	S250T 1S	S250Q	S250Q 2S	S250Q 1S
Continuous Force ¹	40N (9.0lbs)		60N (13.5lbs)	58N (13.0lbs)	75N (16.9lbs)		
Continuous Current ¹	1.3Arms	2.6Arms	1.3Arms	3.8Arms	1.3Arms	2.6Arms	5.1Arms
Acceleration Force ²	160N (36.0lbs)		240N (54.0lbs)	232N (52.2lbs)	300N (67.4lbs)		
Acceleration Current ²	5.1Arms	10Arms	5.1Arms	15.2Arms	5.1Arms	10Arms	20Arms
Force Constant (K _f)	31N/Arms (6.86lbs/amp)	16N/Arms (3.54lbs/amp)	47N/Arms (10.67lbs/amp)	15N/Arms (3.37lbs/amp)	59N/Arms (13.3lbs/amp)	29N/Arms (6.54lbs/amp)	15N/Arms (3.38lbs/amp)
Back EMF (K _e)	10.4V/m/s	5.2V/m/s	16V/m/s	5.1V/m/s	20V/m/s	10V/m/s	4.9V/m/s
Resistance 25°C ³	7.8Ω	2Ω	12Ω	1.3Ω	15Ω	3.8Ω	0.94Ω
Inductance ³	9.8mH	2.5mH	15mH	1.6mH	19mH	4.8mH	1.2mH
Electric Time Constant	1.26ms		1.25ms		1.27ms		
Max. Rated Voltage (AC)	240V						
Fundamental Motor Constant (K _m)	11.19N√W		13.53N√W		15.13N√W		
Magnetic Pitch (North-North)	90mm (3.54lbs)						

Is this the proper Linear Shaft Motor for your application? Use our [SMART sizing program](#) to assist in your decision.

This motor can be customized to fit your application demands; contact your application engineer for more information.

¹ Based on a temp rise of coil surface of 110°K over 25°C ambient temperature stalled forcer, and no external cooling or heat sinking.

² Can be maintained for a maximum of 40 seconds. Higher forces and current possible for short periods of time, consult Nippon Pulse for more information.

³ All winding parameters listed are measured line-to-line (phase-to-phase).

Thermal Specs	S250D	S250T	S250Q
Max Phase Temperature ⁴	135°C (275°F)		
Thermal Resistance (Coil) (K _v)	8.6°C/W (47.5°F/W)	5.6°C/W (42.1°F/W)	4.5°C/W (40.1°F/W)

⁴ The standard temperature difference between the coil and the forcer surface is 20°C.

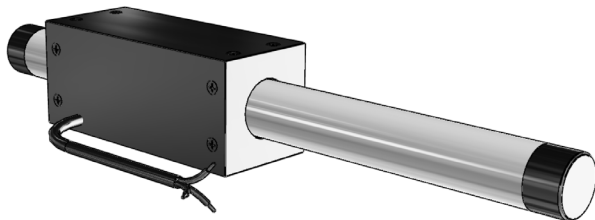

Bus Voltage

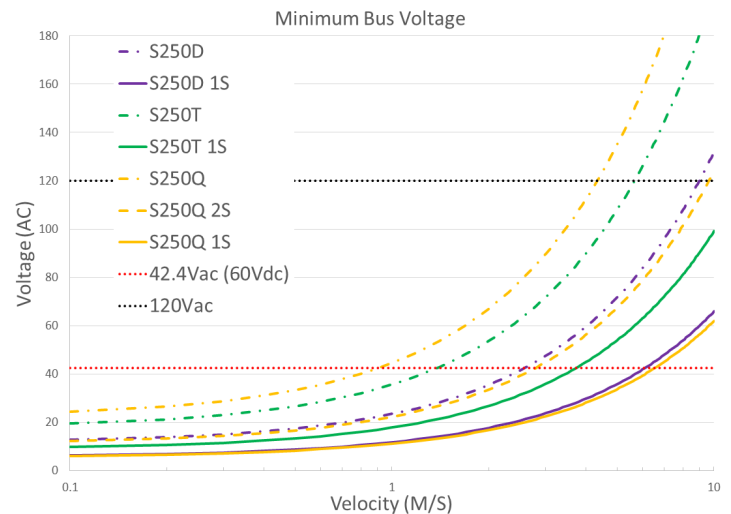

Part Numbering System

S — Shaft Size 250 — Forcer Size (A) X — Parallel Option XX — Usable Stroke (S) XXXXst — Options XX — Options XX

D: Double (2) windings Blank: Single Motor 100-2000mm Blank: Standard Blank: Standard
T: Triple (3) windings PL: Parallel Motors WP: Water Resistant FO: Forcer Only
Q: Quadruple (4) windings CE: CE type motor HA: Digital Hall Effect SO: Shaft Only
X: Octuple (8) windings FG: Frame Ground

Forcer Specs	S250D	S250T	S250Q
Forcer Length (A)	120mm (4.72in)	165mm (6.5in)	210mm (8.27in)
Forcer Width	50mm (1.97in)		
Forcer Screw Pitch (P)	105mm (4.13in)	150mm (5.91in)	195mm (7.68in)
Forcer Weight	0.80kg (1.76lbs)	1.1kg (2.43lbs)	1.5kg (3.31lbs)
Gap	0.75mm (0.03in)		

Tolerances are as follows:

Dimension (mm)	Tolerance (mm)
0 - 6	±0.1
7 - 30	±0.2
31 - 120	±0.3
121 - 315	±0.5
316 - 1000	±0.8
1001 - 2000	±1.2
2000 -	±1.5

L = See Shaft Length
L1 = Usable Stroke + A
L2 = See Support Length
A = See Forcer Length
P = See Forcer Screw Pitch

Unless otherwise specified, dimensions are in mm

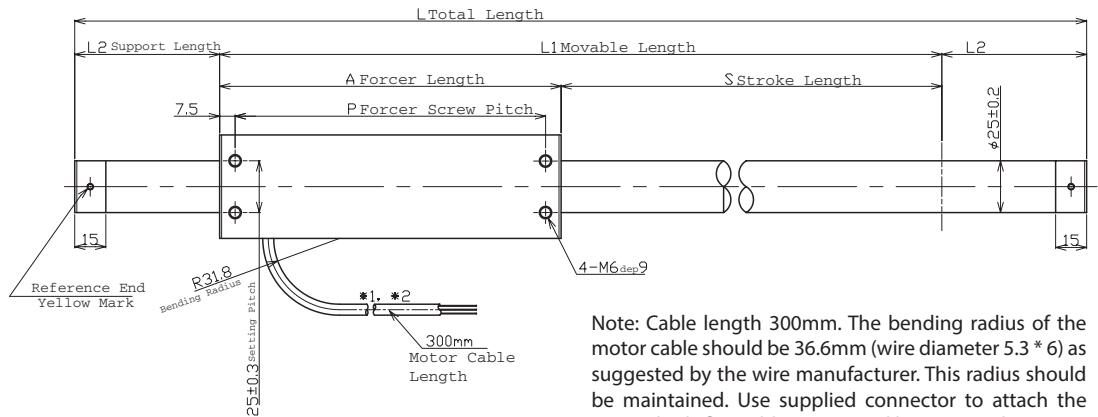

Note: Cable length 300mm. The bending radius of the motor cable should be 36.6mm (wire diameter 5.3 * 6) as suggested by the wire manufacturer. This radius should be maintained. Use supplied connector to attach the proper high-flex cable as required by your application.

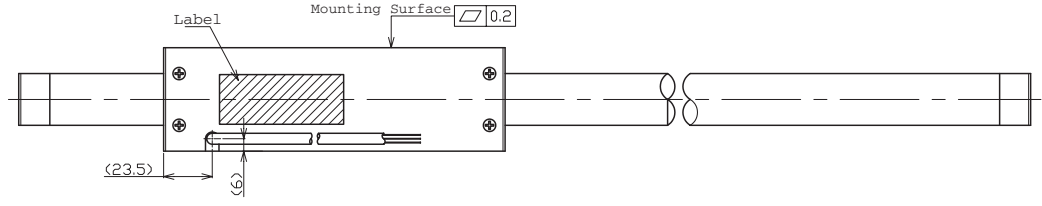
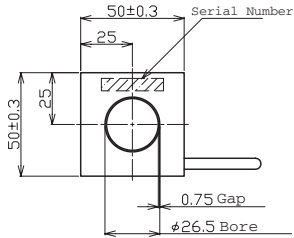

Support and Bending

Stroke D/T/Q	Stroke X	Support Length (L2)	Max. Bending
0~700	0~500	50mm	0.00mm
701~1000	501~800	70mm	0.30mm
1001~1500	801~1300	70mm	0.70mm
1501~max	1301~max	100mm	0.70mm

Shaft Diameter (D) - 25mm ±0.2

Total Length (L)=Stroke (S)+Forcer Length (A)+(Support Length (L2)x2)

Stroke lengths available up to 2550mm. Contact Nippon Pulse for more information.

Forcer Spacing Distance

Spec	S250T
Forcer Spacing Distance	15mm
Pole (N/S) Distance	45mm
Forcer Length	165mm
Flip Forcers	No

Tandem S250D forcers are possible, but are equivalent to one (1) S250Q forcer and thus are not listed. Tandem S250Q forcers are possible, but are equal to one (1) S250X forcer. (See S250X datasheet.)

Tandem Forcer



Hall Effect Specs

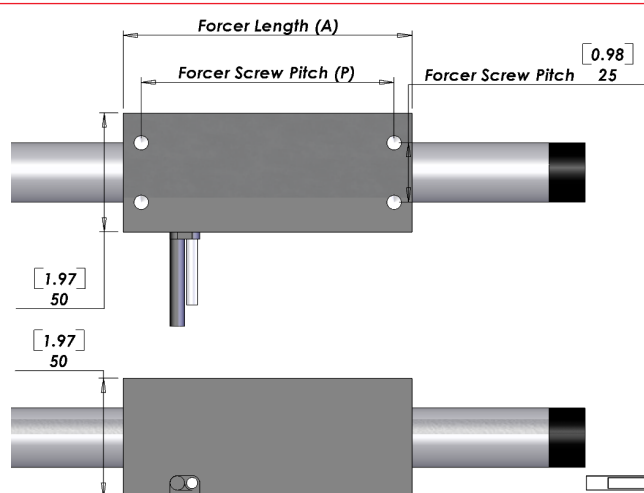

Note 1: The bending radius of the motor cable should be R36.6mm (wire diameter 4.6 * 6) as suggested by the wire manufacturer. This radius should be maintained. Use supplied connector to attach the proper high-flex cable as required by your application.

Sensor Cable Specs

Wire Type	UL 758
Wire AWG	28
VCC	White/Red
GND	White/Black
Sensor 1	Orange/Red
Sensor 2	Orange/Black
Sensor 3	Gray/Red

The bending radius of the sensor cable should be R27.6mm (wire diameter 6.1 * 6) as suggested by the wire manufacturer. This radius should be maintained. Attach the proper high-flex cable as required by your application.

Shaft Length (L)

Stroke	S250D	S250T	S250Q
100	320mm (12.6in)	365mm (14.4in)	410mm (16.1in)
150	370mm (14.6in)	415mm (16.3in)	460mm (18.1in)
200	420mm (16.5in)	465mm (18.3in)	510mm (20.1in)
250	470mm (18.5in)	515mm (20.3in)	560mm (22in)
300	520mm (20.5in)	565mm (22.2in)	610mm (24in)
350	570mm (22.4in)	615mm (24.2in)	660mm (26in)
400	620mm (24.4in)	665mm (26.2in)	710mm (28in)
450	670mm (26.4in)	715mm (28.1in)	760mm (29.9in)
500	720mm (28.3in)	765mm (30.1in)	810mm (31.9in)
550	770mm (30.3in)	815mm (32.1in)	860mm (33.9in)
600	820mm (32.3in)	865mm (34.1in)	910mm (35.8in)
650	870mm (34.3in)	915mm (36in)	960mm (37.8in)
700	920mm (36.2in)	965mm (38in)	1010mm (39.8in)
750	1010mm (39.8in)	1055mm (41.5in)	1100mm (43.3in)
800	1060mm (41.7in)	1105mm (43.5in)	1150mm (45.3in)
850	1110mm (43.7in)	1155mm (45.5in)	1200mm (47.2in)
900	1160mm (45.7in)	1205mm (47.4in)	1250mm (49.2in)
950	1210mm (47.6in)	1255mm (49.4in)	1300mm (51.2in)
1000	1260mm (49.6in)	1305mm (51.4in)	1350mm (53.1in)
1050	1310mm (51.6in)	1355mm (53.3in)	1400mm (55.1in)
1100	1360mm (53.5in)	1405mm (55.3in)	1450mm (57.1in)
1150	1410mm (55.5in)	1455mm (57.3in)	1500mm (59.1in)
1200	1460mm (57.5in)	1505mm (59.3in)	1550mm (61in)
1250	1510mm (59.4in)	1555mm (61.2in)	1600mm (63in)
1300	1560mm (61.4in)	1605mm (63.2in)	1650mm (65in)
1350	1610mm (63.4in)	1655mm (65.2in)	1700mm (66.9in)
1400	1660mm (65.4in)	1705mm (67.1in)	1750mm (68.9in)
1450	1710mm (67.3in)	1755mm (69.1in)	1800mm (70.9in)
1500	1760mm (69.3in)	1805mm (71.1in)	1850mm (72.8in)
1550	1870mm (73.6in)	1915mm (73.6in)	1960mm (77.2in)

Shaft Mass

Stroke	S250D	S250T	S250Q
100	0.9kg (2lb)	1.1kg (2.3lb)	1.2kg (2.7lb)
150	1.1kg (2.4lb)	1.2kg (2.7lb)	1.4kg (3.1lb)
200	1.2kg (2.7lb)	1.4kg (3.1lb)	1.6kg (3.4lb)
250	1.4kg (3.1lb)	1.6kg (3.5lb)	1.7kg (3.8lb)
300	1.6kg (3.5lb)	1.7kg (3.8lb)	1.9kg (4.2lb)
350	1.8kg (3.9lb)	1.9kg (4.2lb)	2.1kg (4.6lb)
400	1.9kg (4.3lb)	2.1kg (4.6lb)	2.2kg (4.9lb)
450	2.1kg (4.6lb)	2.3kg (5lb)	2.4kg (5.3lb)
500	2.3kg (5lb)	2.4kg (5.4lb)	2.6kg (5.7lb)
550	2.4kg (5.4lb)	2.6kg (5.7lb)	2.8kg (6.1lb)
600	2.6kg (5.8lb)	2.8kg (6.1lb)	2.9kg (6.5lb)
650	2.8kg (6.2lb)	2.9kg (6.5lb)	3.1kg (6.8lb)
700	3kg (6.5lb)	3.1kg (6.9lb)	3.3kg (7.2lb)
750	3.2kg (7lb)	3.4kg (7.4lb)	3.5kg (7.7lb)
800	3.4kg (7.4lb)	3.5kg (7.8lb)	3.7kg (8.1lb)
850	3.5kg (7.8lb)	3.7kg (8.1lb)	3.8kg (8.5lb)
900	3.7kg (8.2lb)	3.9kg (8.5lb)	4kg (8.9lb)
950	3.9kg (8.6lb)	4kg (8.9lb)	4.2kg (9.2lb)
1000	4.1kg (8.9lb)	4.2kg (9.3lb)	4.4kg (9.6lb)
1050	4.2kg (9.3lb)	4.4kg (9.7lb)	4.5kg (10lb)
1100	4.4kg (9.7lb)	4.6kg (10lb)	4.7kg (10.4lb)
1150	4.6kg (10.1lb)	4.7kg (10.4lb)	4.9kg (10.8lb)
1200	4.7kg (10.5lb)	4.9kg (10.8lb)	5.1kg (11.1lb)
1250	4.9kg (10.8lb)	5.1kg (11.2lb)	5.2kg (11.5lb)
1300	5.1kg (11.2lb)	5.2kg (11.6lb)	5.4kg (11.9lb)
1350	5.3kg (11.6lb)	5.4kg (11.9lb)	5.6kg (12.3lb)
1400	5.4kg (12lb)	5.6kg (12.3lb)	5.7kg (12.7lb)
1450	5.6kg (12.3lb)	5.8kg (12.7lb)	5.9kg (13lb)
1500	5.8kg (12.7lb)	5.9kg (13.1lb)	6.1kg (13.4lb)
1550	6kg (13.3lb)	6.2kg (13.6lb)	6.3kg (14lb)

Additional stroke lengths are available (up to 2615mm for S250D, 2570mm for S250T, and 2525mm for S250Q). Contact Nippon Pulse for more information.

FG Type Motor Cable

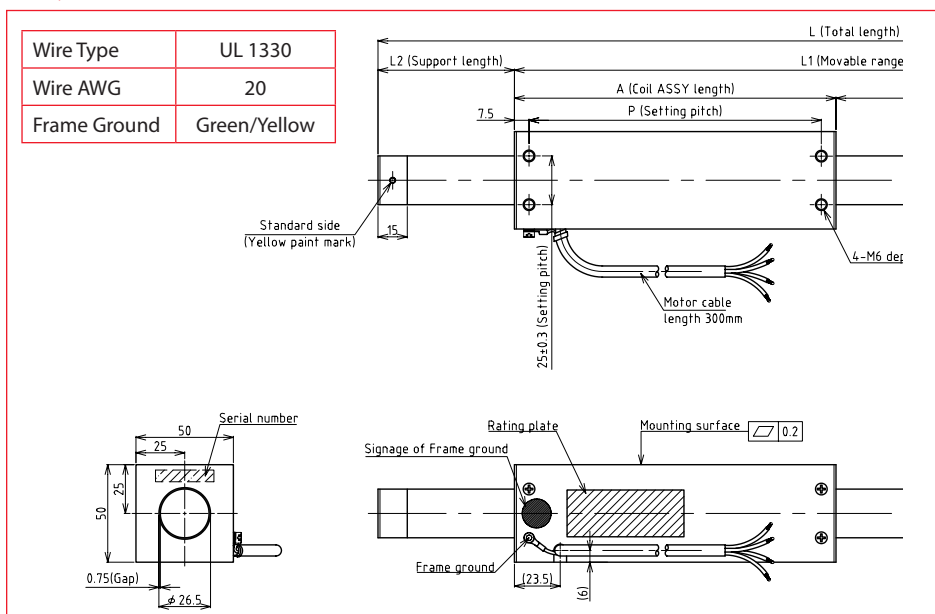

Connector (Motor Cable)

Receptacle Housing	HLR-03V
Plug Housing	HLP-03V
Retainer	HLS-03V
Pin Contact	SSM-21T-P1.4
Socket Contact	SSF-21T-P1.4

To be installed by the user.

Thermocouple

Thermal sensor
Thermocouple K type (marked each phase name)
Attached to the surface of inside of coil
Length 3000mm

Standard Lead Wire

Wire Type	UL 2464FA
Wire AWG	20
U Phase	Red
V Phase	White
W Phase	Black

300mm lead wire bare leads. The bending radius of the motor cable should be 36.6mm as suggested by the wire manufacturer.

CE Option - CE Type Lead Wire

Ground Wire	CE
Wire Type	UL 1330
Wire AWG	24
U Phase	Red
V Phase	White
W Phase	Black

300mm lead wire bare leads. The bending radius of the motor cable should be 18.96mm as suggested by the wire manufacturer. FG type with insulating sheet between coils and case. Meets all requirements of EN60034-1 (1998).

THM Option

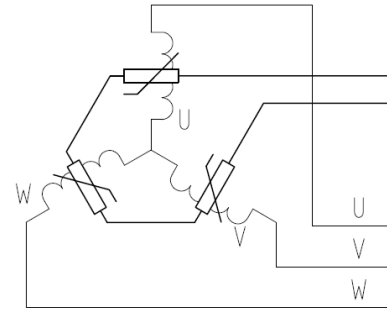

Circuit Diagram

4. Thermistor

PTCSL20T071DBE(Vishay)

Note: Metric units guaranteed. Imperial (United States customary) units are calculated.

For assistance in selecting the best motor for your application, contact Nippon Pulse to speak with an applications engineer. 1-540-633-1677

www.nipponpulse.com