

- High Thrust, High Speed, High Responsiveness, High Precision, Long Stroke
- Simple Design and Easy Installation
- Non-Contact Drive means Low Noise, Long Lifespan, and Maintenance-Free

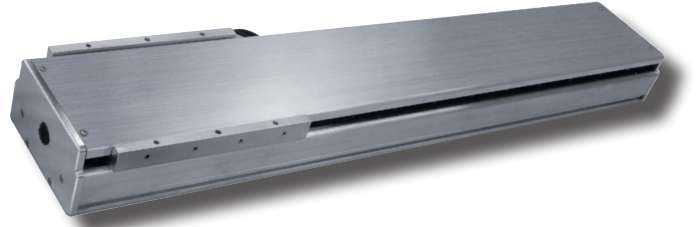

Stage Specifications

Rated Spec	Unit	Specification
Encoder Resolution	μm	1 (HEIDENHAIN LIDA279)
Continuous Force	N	80
Acceleration Force ¹	N	340
Continuous Current ²	A	1.2
Acceleration Current ¹	A	5.1
Force Constant (Kf)	N/A rms	66
Back-EMF Constant	V/m/s	22
Resistance ³	ohm	22
Inductance ³	mH	31
Magnetic Pitch (N-N)	mm	90
Maximum Acceleration ⁴	G	3.5
Maximum Velocity ^{4, 5}	m/s	3.0
Bi-Directional Repeatability	mm	±0.0005
Max Load, Horizontal	kg	30
Load Capacity	kg	15
Stroke, Single Forcer ⁶	mm	200-2000 (100 interval)
Stroke, Double Forcer ⁶	mm	200-1800 (100 interval)
Operating Temperature	°C	0~+40
Operating Humidity	%	20~80 (no condensation)
Storage Temperature	°C	-20~+60
Moving Mass	kg	2.7

Note 1: Acceleration Force given is based on the output with the use of the following driver - SLP25: (14) Hitachi Production Machine System ADA3-01LL2

Note 2: The effective amperage when the temperature increase of the coil front becomes 110K

Note 3: An average value of U-V, U-W, and V-W

Note 4: There are instances when this is not achieved due to load or operation specifications

Note 5: There are instances when this is not achieved due to the length of the stroke

Note 6: Contact NPA for longer stroke lengths

Overhanging Weight Tolerance (mm)

	Load	0°	45°	90°
Horizontal	5kg	1000	1000	1000
	10kg	1000	800	1000
	15kg	800	650	1000
	20kg	700	580	1000
	25kg	550	500	1000
	30kg	500	450	1000
Wall	3kg	1000	1000	580
	6kg	1000	800	450
	9kg	1000	670	400
	12kg	1000	580	350
	15kg	1000	500	300

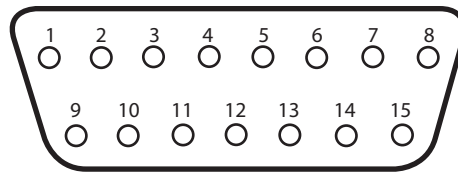
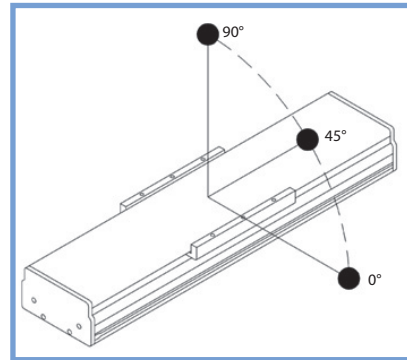

Pin	Signal	Wire Color	Function
1	A+	White	Incremental Signal
2	0V	Black/Red	Ground
3	B+	Green	Incremental Signal
4	5V	Red	Power
7	Z-	Black/Yellow	Reference Mark
9	A-	Black/White	Incremental Signal
11	B-	Black/Green	Incremental Signal
14	Z+	Yellow	Reference Mark

F-V Curve

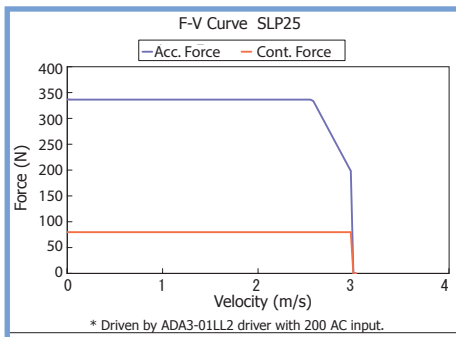

Max. Acceleration vs. Load

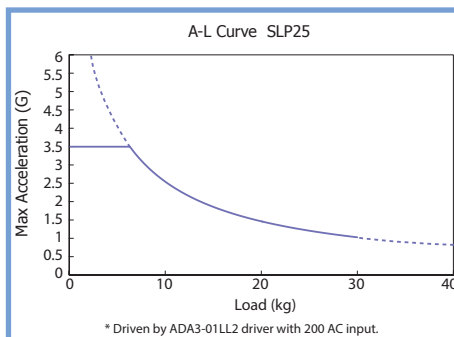

Position Repeatability

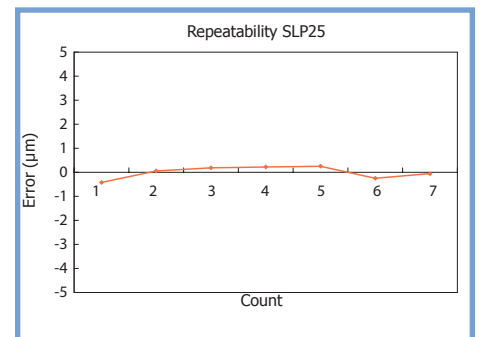

Single Slider Dimensions

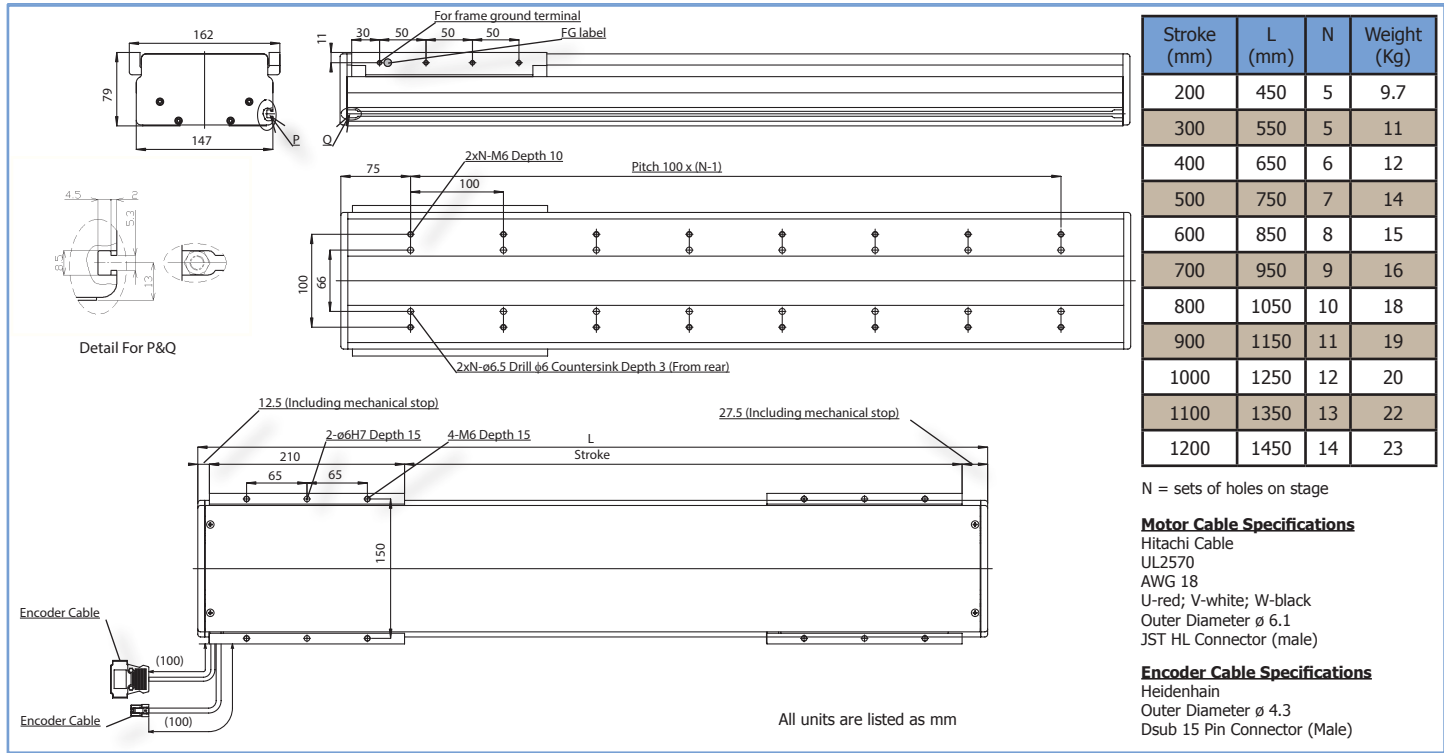

Double Slider Dimensions

