

P R O D U C T C A T A L O G

NPM Nippon Pulse
Your Partner in Motion Control

N I P P O N P U L S E . C O M

TABLE OF CONTENTS

Stepper Motors	3
Tin-Can Steppers Overview	5
Linear Stepper Motors Overview	6
Customization Options	7
Rotary Hybrid Motors Overview	8
Linear Hybrid Motors Overview	9
Packaged Systems Overview	10
Synchronous Motors Overview	11
Servomotors	12
Linear Shaft Motor Overview	13
Motor Configurations	14
Drive Setup and Configuration Examples	15
Linear Shaft Motor Part Numbering Guide	16
Other Linear Shaft Motor Options	16
Rotary Servomotors Overview	17
Linear Stages	18
Linear Shaft Motors Integrated into Linear Stages	19
SCR Nanopositioning Stages	20
SLP Acculine Stages	21
Motion Control Electronics	22
Electronics Overview	23
Calculations, Motion Profiles and Technical Overview	24
Controller Chips and Boards	26
Box-Level Controllers	27
Commander Core for Custom Solutions	28
Driver Boards and Other Electronics	29
Custom PCB Design	29
Engineering Resources	30
Development and Evaluation Kits	31
Formulas for Stepper Motor Selection	32
Linear Shaft Motor Selection Guide	33
Useful Formulas for Common Motion Profiles	34
Motor Sizing Example	35
About Nippon Pulse	36
Resources for Further Learning	36
Nippon Pulse Group Worldwide	37

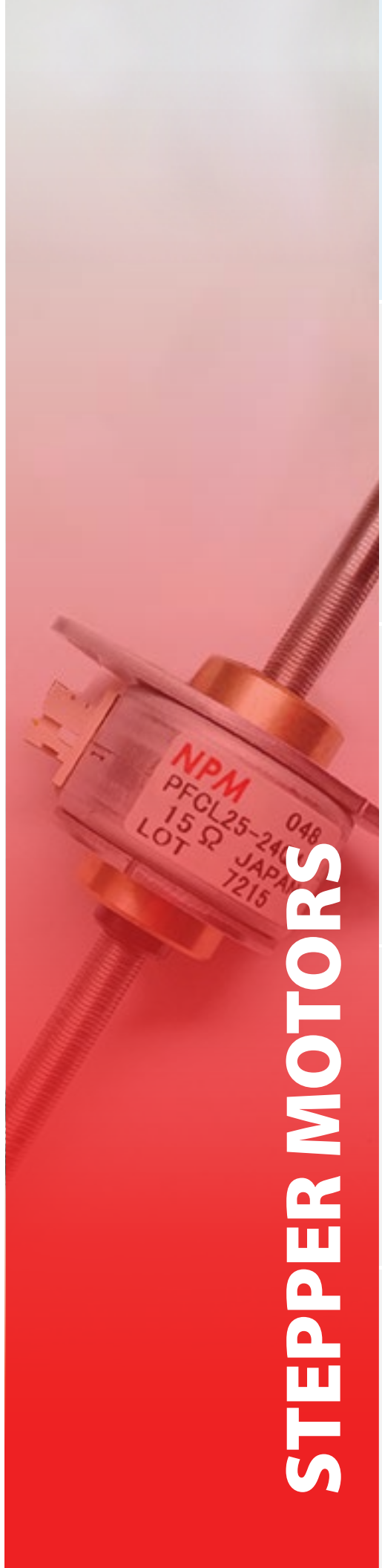
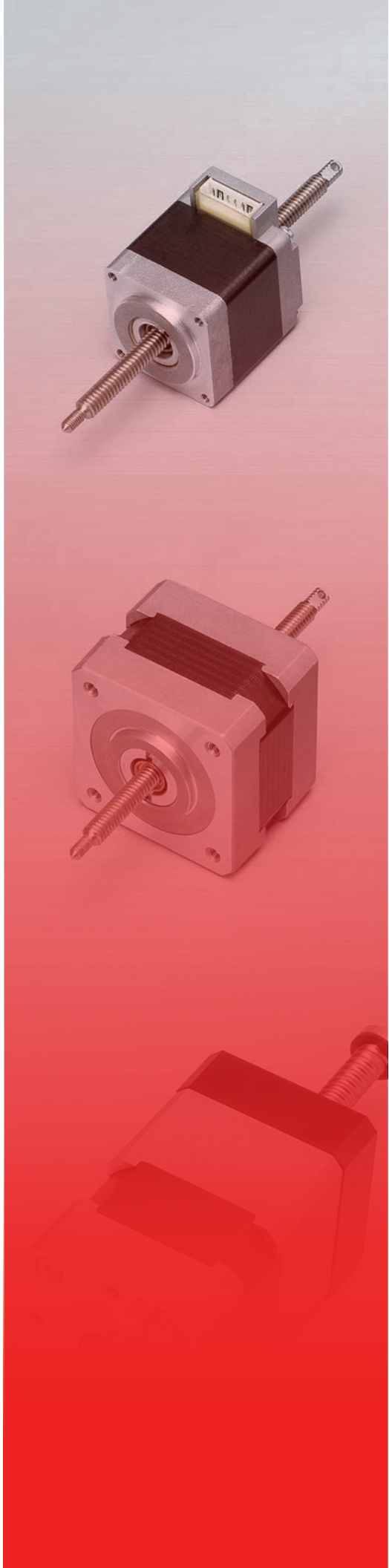

STEPPER MOTORS

STEPPER MOTORS

SERVOMOTORS

STAGES

ELECTRONICS

ENGINEERING RESOURCES

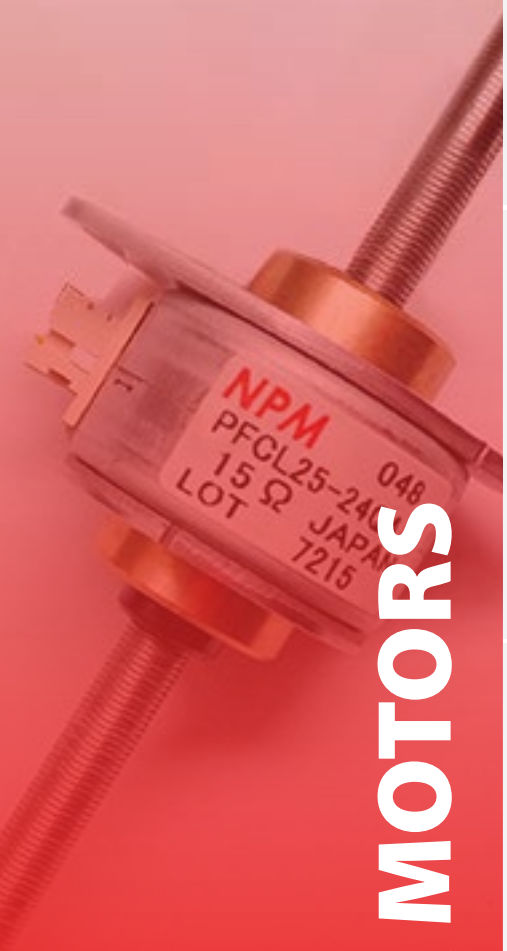

Stepper Motors Product Overview

Permanent Magnet Motors

Nippon Pulse's permanent magnet (PM) stepper motors (PF series tin-can steppers) have been well-established in the engineering world, and have many advantages over other kinds of stepper motors. PM motor strike the perfect balance between efficiency and affordability, as they are low-inertia, low-resolution motors that are a low-priced alternative to hybrid stepper motors in many applications.

PM step motors have a typical step angle between 3.75 and 18 degrees, and offer position resolution on the order of ± 5 percent. Its structure demonstrates ferromagnetism, with alternating north and south poles set in a straight parallel line to the rotor shaft. The rotor is moved through the action of permanent magnets, providing increased magnetic flux intensity. This intensity results in improved torque characteristics for the PM motor, compared to variable resistance step motors.

Nippon Pulse provides high-quality PM motors to industries and professionals all over the world. Take a look at our standard PM motors over the following pages to find the one that most closely fits your needs. An application engineer can work with you to make any customizations necessary to make our PM motors a perfect fit.

Basic Structure of 2-Phase Permanent Magnet Motor

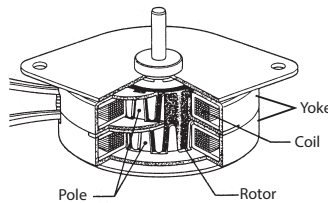

Nippon Pulse Stepper Motor Series

- Rotary Tin-Can Stepper Motors (PF, PFC series)
- Linear Tin-Can Stepper Motors (PFCL, PFL motors)
- Rotary Hybrid Stepper Motors (PJP, PJE series)
- Linear Hybrid Stepper Motors (PJPL motors)
- Ballscrew Linear Actuators (PJLT motors)
- Synchronous Motors (PTM, PTMC series)

RoHS Compliance

All Nippon Pulse stepper motor products are RoHS compliant.



Applications

Laboratory Automation	Machinery	Office Automation	Commercial/Entertainment
Liquid Handling Digital Adjustable Pipettes Automated Pipetting Systems Peristaltic Pumps Syringe Pumps Sample Handling Pick and Place Microscope Automation Robotic Grippers Syringe Automation Liquid Dispensing Lens Control	Textile Machines Oil Pressure Gauge Welding Equipment Feeders Material Testing Valves Boiler Chemical Monitoring Agricultural Equipment Seed Distribution Chlorine Analyzers	Security Camera Automation Printers Thermal Printers 3D Printers Video Conferencing Systems Bill Handling Currency Validation ID Printers	Telescopy Vending Machines Metronome Gaming Machines ATM Machines Crane Game

Please visit nipponpulse.com/support for complete product specifications.

Tin-Can Steppers Overview

Rotary Stepper Motors Since 1965

Nippon Pulse's stepper motors offer a conventional, magnet-driven rotary stepper motor that is both high-performance and cost-efficient. Nippon Pulse has been manufacturing the rotary stepper motor since 1965.

Several customization options are available for all tin-can steppers (both rotary and linear), and any of our standard-sized motors can be fully custom-designed to meet the unique needs of your application. Standard rotary tin-can steppers available in diameter sizes from 10mm to 55mm.

Advantages of Tin-Can Steppers

- High-performance stepper motors
- Speed changes depending on the pulse signal frequency
- Multiple step angles to choose from, as well as thin-stack, high-torque and gearhead options

Rotary Tin-Can Stepper Motor Part Numbering

PF(C) - 42	T - 48	C	1	G	1/50
1	2	3	4	5	6
7	8				

- 1 - Series Designation
PF: Flying lead joint type
PFC: Connector joint type
 - 2 - Outer Diameter in mm
 - 3 - Type
Blank: Standard
T: Thin stack
H: High torque
 - 4 - Steps per Revolution
 - 5 - Winding
C: 12V unipolar
D: 5V unipolar
P: 12V bipolar
Q: 5V bipolar
 - 6 - Magnet Material
1: Ferrite Anisotropic
3: Ferrite Isotropic
4: Neodymium
6: Molded Neodymium*
 - 7 - Gear Head
Blank: No Gear Head
G: Gear Head Integrated
 - 8 - Gear Ratio
On geared models only
- *Only applicable for PFC10.

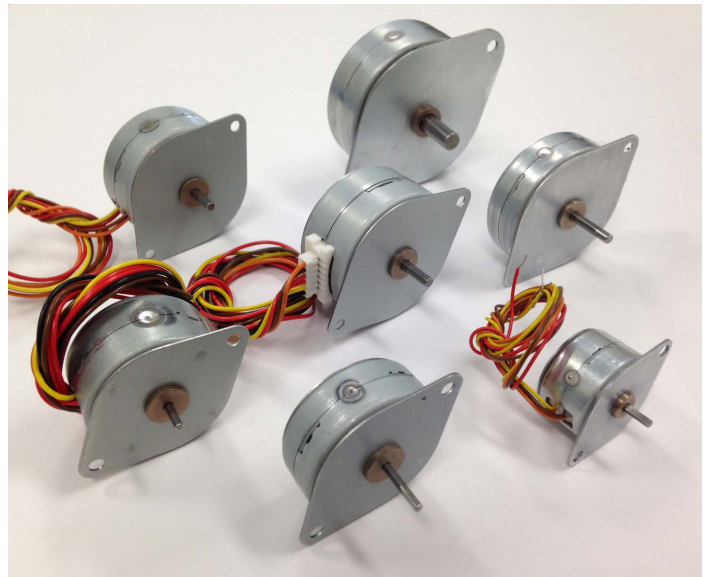

Tin-Can Motors by Size

Outer Diameter (mm)	Rotary Stepper	Linear Stepper
10	PFC10	--
20	PFCU20	PFL20
25	PF(C)25 PFCU25	PFCL25
30	PFCU30	--
35	PF35 PF35T	PFL35T
42	PF42 PFC42H PF(C)42T	--
55	PF(C)55 PFC55H	--

Unipolar Drive

Six lead wires are connected

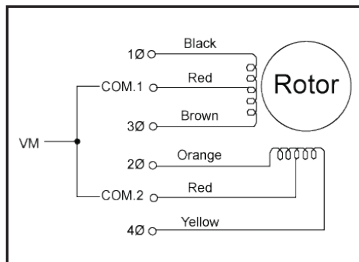

Current: Single direction
Coil: Bifilar winding
Leadwires: 6

The basic circuit (constant voltage) is shown to the right

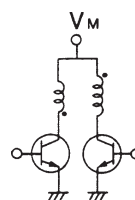

Bipolar Drive

Four lead wires are connected

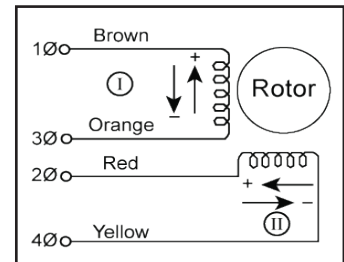

Current: Dual direction
Coil: Monofilar winding
Leadwires: 4

The basic circuit (constant voltage) is shown to the right

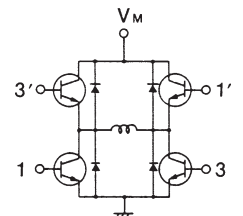

Please visit nipponpulse.com/support for complete product specifications.

Linear Stepper Motors Overview

LinearStep

Our tin-can linear actuators are designed to provide a simple system at a fraction of the cost of a conventional rotary-to-linear stepper system. Offered in diameters of 20mm, 25mm and 35mm, the LinearStep series can be ordered with one of three thread pitches on the lead screw (0.48mm, 0.96mm, and 1.2mm); when the thread pitch and pulse rate change, the speed will also change. LinearStep motors are available with either a bipolar or unipolar winding.



Advantages of LinearStep Motors

- Sizes available in 20mm, 25mm and 35mm diameters
- Captive and non-captive models available
- Easily controllable
- Additional winding options are available to meet application requirements
- Simple structure (threaded rotor hub and lead screw) - ball-bearings support the low-friction screw for long product life

LinearStep Benefits Over Rotary-to-Linear Motion

- Save space and reduce costs (fewer mechanical parts needed for linear motion)
- Motor's simple structure saves design time
- Efficient

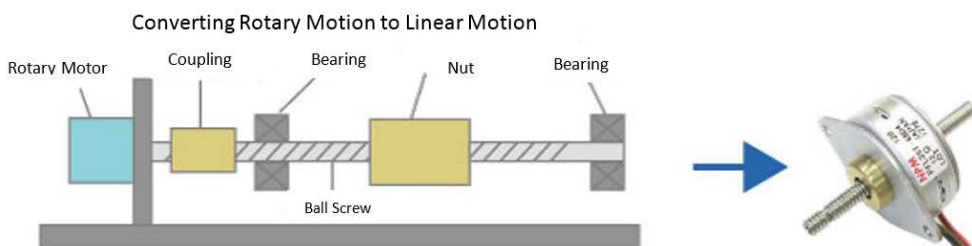

Unipolar Drive

Six lead wires are connected

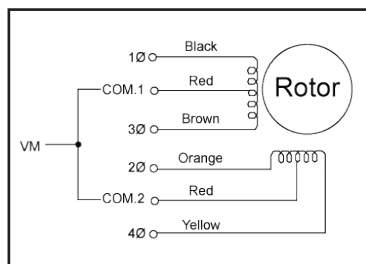

Bipolar Drive

Four lead wires are connected

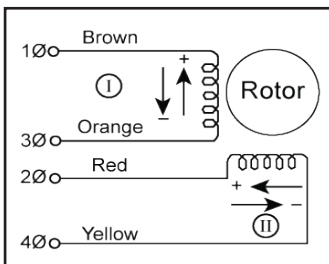

LinearStep Motor Part Numbering

PF(C)	L	25	T	-	48	Q	4	-	048	-	30
1	2	3	4		5	6	7		8		9

- | | |
|--|---|
| 1: Series Designation
PF: Standard
PFC: Connector | 7: Magnet Material |
| 2: LinearStep Designation | 8: Thread Pitch
048: 0.48mm
096: 0.96mm |
| 3: Motor Diameter (mm)
120: 1.20mm | 9: Stroke/shaft in mm
30: 30mm stroke, 60mm shaft
60: 60mm stroke, 90mm shaft |
| 4: Thin stack (optional) | |
| 5: Steps per Revolution | |
| 6: Winding
C: 12V unipolar
D: 5V unipolar
P: 12V bipolar (PFCL25)
Q: 5V bipolar
R: 12V bipolar (PFL35T) | |

Please visit nipponpulse.com/support for complete product specifications.

Customization Options for Tin-Can and LinearStep Motors

Motor Customization and Custom Motor Manufacturing

Nippon Pulse understands that each motor application may require modifications to off-the-shelf products.

In addition to fully custom motor designs, below are some of the modifications we can offer on our standard tin-can, synchronous and linear stepper motors. We also offer customizations and fully custom Linear Shaft Motors to meet your application requirements. Any of our standard series motors can be customized to meet the unique needs of your application.

Contact Nippon Pulse for more information on product customization or fully custom motor designs.

Shaft Modifications



Flat(s)



Knurling



V-Groove



Thru-Hole



Threading



Pinion Gear
(press fit, set screw or spring pin)



Extended Shaft



Double Shaft

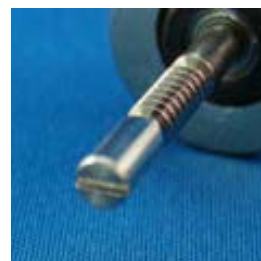

Slot



Worm Gear

Additional Modifications



Longer or Shorter
Lead Length



Connectors



Plastic Tubing
(regular or heat shrink)



Twisted Leads



Ball Bearings



Flange



Lead Wire Exit Location



Mesh Tubing



Stopper

Rotary Hybrid Motors Overview

Superior Response Hybrid Motors

Nippon Pulse's PJP unipolar and PJE bipolar series of rotary hybrid motors are ideal for motion control applications where the benefits of smaller size with high torque are essential. They feature superior response characteristics and function in a wide variety of applications.

Features

- Unipolar and bipolar options
- Sizes from 20mm to 86mm
- Variety of stack lengths

Applications

- Automation
- Document processing
- Printers, copiers and sorters
- Chart recorders and plotters
- Rotary positioning
- Robot grippers



Unipolar Drive

Six lead wires are connected

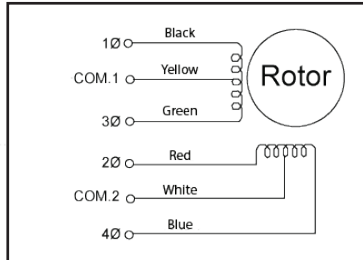

Bipolar Drive

Four lead wires are connected

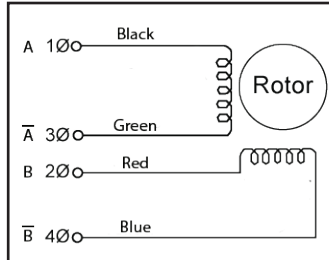

Hybrid Motors by Size

Outer Diameter (mm)	NEMA Size	Rotary Hybrid	Linear Hybrid	Linear Hybrid Ballscrew
20	8	PJE20		--
28	11	PJE28 PJP28	PJPL28	PBAAR28 PBACL28 PJPL28T
35	14	PJE35		--
42	17	PJE42 PJP42	PJPL42	PBAAR42 PBACL42 PJPL42T
56	23	PJP56	PJE series: Bipolar PJP series: Unipolar	
57	23	PJE57		
60	24	PJE60	PBAAR: Captive PBACL: Non-Captive	
86	34	PJE86		

Rotary Hybrid Part Numbering

PJP 42 T 34 D 1 6 -xx
1 2 3 4 5 6 7 8

- 1: Series Designation
PJP: unipolar
PJE: bipolar
- 2: Motor Size (mm)
- 3: Design version
- 4: Stack length
- 5: Winding
- 6: Shaft (1, 2)
- 7: Leads
- 8: Customizations (xx)

Please visit nipponpulse.com/support for complete product specifications.

Linear Hybrid Motors Overview

Rotary Motion to Linear Motion

Nippon Pulse's linear hybrid stepper motors (PJPL unipolar; PBA series) feature superior response characteristics, and include an integral lead screw or ball screw for converting rotary motion into linear motion.

Our linear hybrid stepper motors are ideal for a wide variety of applications, including medical devices, microtiter tables, fluid dispensers, semiconductor wafer handling machines, optical systems, and data storage machines.

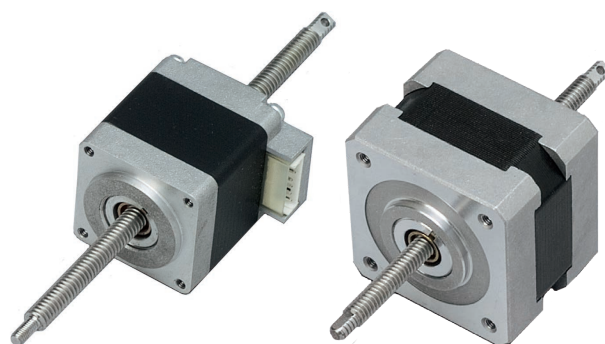

Features of Leadscrew Hybrid Motors

- NEMA 11 and 17 mount face for unipolar models
- NEMA 8, 11, 14 and 17 mount face for bipolar models

Features of Ballscrew Hybrid Motors (PBA series)

- More efficient than leadscrew actuators
- NEMA 11 and 17 mount face
- Compact size reduces number of parts and saves space
- Captive type includes anti-rotating device, with combination Ball Screw with Ball Spline (BSSP) and hollow motor



Internal Structure of PBA Series Motor (Ballscrew)

NPM's PBA series actuators are equipped with a hollow motor combined with KSS Miniature Ball Screw or BSSP. NPM designed the motor with a larger hollow hole without having to reduce torque.

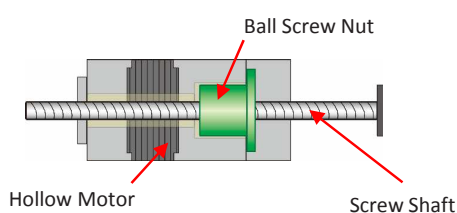

Non-Captive Type

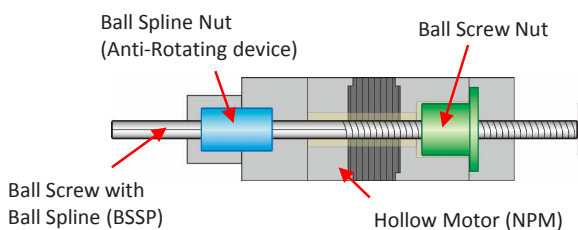

Captive Type

Linear Hybrid Part Numbering (Leadscrew)

PJPL 42 33 D 6 100 -xx
 1 2 3 4 5 6 7

- | | |
|--|------------------------------|
| 1: Series Designation
PJPL: unipolar | D = 1.2A
E = 0.95A |
| 2: Motor Size (mm) | 5: Lead Wires (6 or 4) |
| 3: Case Length | 6: Thread Pitch
100 = 1mm |
| 4: Winding
A = 2A
B = 1A
C = 0.5A | 7: Customizations |

Linear Hybrid Part Numbering (Ballscrew)

PBA CL 28 G 01 040
 1 2 3 4 5 6

- | | |
|--|---------------------------|
| 1: Series Designation | 4: Ball screw type |
| 2: Cylinder type
CL: Non-Captive
AR: Captive | G: Precision
R: Rolled |
| 3: Frame size (mm) | 5: Screw Lead (mm) |
| | 6: Travel (mm) |

Please visit nipponpulse.com/support for complete product specifications.

Motion Control Kits

Get your application up and running fast with new pre-packaged solutions!

SmartPak and PulsePak are packaged solutions that contain a hybrid stepper motor with integral encoder, a servo controller (either a programmable controller-driver or a pulse & direction driver) and a cable kit to connect everything together. Purchasing your packaged solution is easy - order a single part number, and all necessary components will be included in a single box. Bulk shipments also available with reduced packaging.

Features

- Nippon Pulse hybrid stepper motor with integral 1000 or 2500 cpr encoder
- Motor available in NEMA sizes 8 through 34
- Easy BASIC programming controller
- Real-time servo / closed-loop control
- Compatible with: 2 phase stepper, 3 phase brushless servo, 2 phase linear servo, DC brushed, and voice coil motors



Applications

- Factory Automation
- Lab Automation
- Semiconductor
- Packaging and Labeling Machines

Motion Control Kit Part Numbering

MCK - 17 D 2 E1 NX-SCX
 1 2 3 4 5 6

Electronics:

- PulsePak features NEXUS Pulse and Direction Driver
- SmartPak features NEXUS All-in-One Servo Driver and Controller

- | | |
|-----------------------|-------------------------|
| 1: Series Designation | 5: Encoder |
| 2: NEMA size | E1: 1000 cpr |
| 3: Motor winding* | E2.5: 2500 cpr |
| 4: Stack length | 6: Nexus Controller Kit |
| 1: single | NX-SCX: SmartPak |
| 2: double | NX-SVX: PulsePak |
| 3: triple | |

*see datasheet for the PJE series motor size selected



a **NEXUS** alliance member

Please visit nipponpulse.com/support for complete product specifications.

Synchronous Motors Overview

No Power or Load Fluctuation Effect

Synchronous motors rotate in synch with supplied power frequency. If power frequency is constant, the motor will rotate at a constant speed (synchronized speed). Unless otherwise stated, these motors provide high electrical resistance, which prevents overcurrent from flowing to the motor, which would in turn burn the coils. The type of magnet used in these motors ensures excellent response and also ensures the motor will start and stop immediately when power is supplied or removed.

Capacitor Required

With reversible synchronous motors (can rotate both clockwise and counterclockwise) the rotor is moved by shifting the phase by 90 degrees. Thus, a synchronous motor requires a capacitor, which should withstand a voltage of greater than twice the rated voltage of the motor.



Features

- Sizes from 25mm to 55mm (depending on single or dual direction)
- No control circuit required: these AC motors start rotating when a power connection is made
- Single or dual direction (single direction does not require any specific wiring to the AC power supply, and the leadwires have no polarity)

Synchronous Motors by Size

Outer Diameter (mm)	Synchronous	
	Dual Direction	Single Direction
25	PTMC-24P	--
35	PTM-24M PTM-24T	PTM-24B
42	PTM-24H	PTM-12E PTM-24AG
55	PTM-24F	--

Dual Direction Part Numbering

PTM(C) - 24 F 3 4 G 1/2
 1 2 3 4 5 6 7

- | | |
|--|--|
| 1: Series Designation
PTM: Flying lead type
PTMC: Connector | H: 42mm
F: 55mm |
| 2: Number of Poles
12: Speed is 500 rpm w/
50Hz, 600 rpm w/ 60Hz
24: Speed is 250 rpm w/
50Hz, 300 rpm w/ 60Hz | 4: Winding
Blank: Standard Coil
1-18: Coil # for
specific rating |
| 3: Outer Diameter (Type)
P: 25mm
M: 35mm
T: 35mm (thin) | 5: Magnet Type
6: Gear Head
Blank: No Gear Head
G: Gear Head
7: Gear Ratio |

Single Direction Part Numbering

PTM - 24 B G 100 - 50/60 - 2/2.4 CW
 1 2 3 4 5 6 7 8

- | | |
|--|--|
| 1: Series Designation | 4: Gear Head |
| 2: Number of Poles
12: Speed is 500 rpm w/
50Hz, 600 rpm w/ 60Hz
24: Speed is 250 rpm w/
50Hz, 300 rpm w/ 60Hz | Blank: No gear head
G: Gear head |
| 3: Outer Diameter
B: 35mm
E: 42mm (high torque) | 5: Supply Voltage
24, 100, 200 Vac
6: Power Frequency
50, 60, or 50/60Hz
7: Rotating Speed
8: Direction |

Please visit nipponpulse.com/support for complete product specifications.

ENGINEERING RESOURCES

ELECTRONICS

STAGES

SERVOMOTORS

STEPPER MOTORS

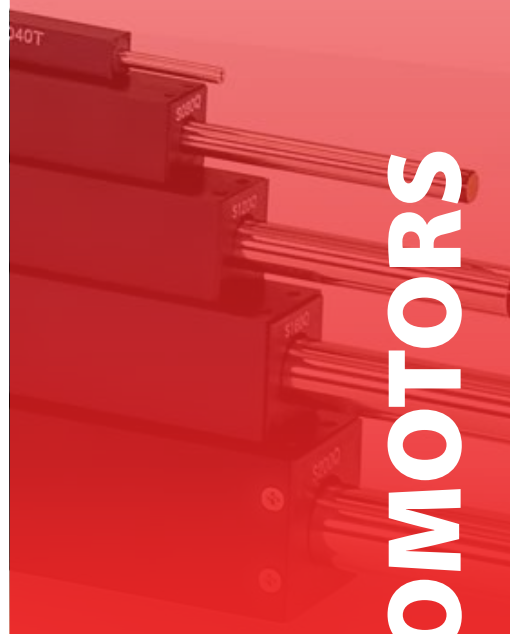

SERVOMOTORS

Linear Shaft Motor Overview

Simple, Non-Contact, High Precision

The Linear Shaft Motor is an ultra-high-precision direct drive linear servomotor consisting of only two parts: a magnetic shaft and a “forcer” of cylindrically wound coils. The forcer assembly, combined with the amplifier and control electronics, produces the force for the motor. The motor contains no iron, resulting in zero cogging, though the coils of the forcer provide the stiffness expected from an iron-core motor.

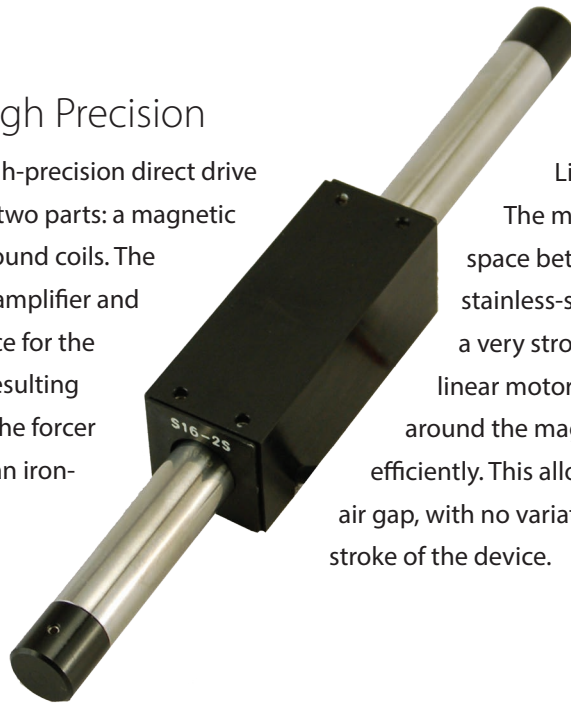

Linear Shaft Motors are also non-contact. The magnetic shaft is built such that there is no space between the magnets within the cylindrical stainless-steel tube. The patented process produces a very strong magnetic field twice that of other linear motors. Since the forcer coil completely wraps around the magnets, all the magnetic flux is used efficiently. This allows for a large (0.5 to 5.0mm) non-critical air gap, with no variation in force as the gap varies over the stroke of the device.

Advantages of the Linear Shaft Motor

- Compact, lightweight design requires less power while producing a comparable force to that of a similar-sized traditional linear motor.
- High precision (0.07nm)¹ and precise micropositioning.
- Capable of high thrust (up to 100,000N), stroke of up to 4.6 meters and virtually no speed fluctuation ($\pm 0.006\%$ at 100mm/s).
- No heat sinks required. All sides of the forcer coil are positioned to allow for maximum heat dissipation and efficiency.
- Easy installation, alignment and system integration.
- Quiet operation, due to the absence of friction; the only mechanical contact is the linear guide (though fully non-contact operation is possible using an air slider).
- Durable construction, capable of operation even in a vacuum, in a harsh environment, or underwater.
- Available in shaft diameters as small as 4mm and as large as 60mm.

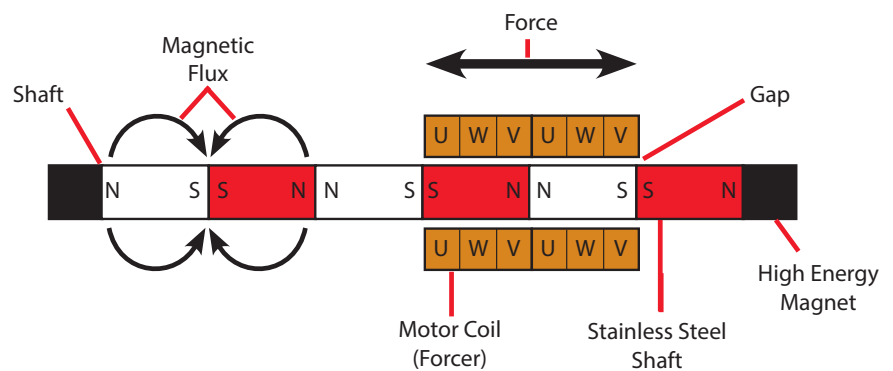

¹ Repetitive positioning precision is dependent on the resolution of the linear encoder. It is also necessary to have sufficient machine rigidity. Absolute positioning precision is fundamentally dependent on the linear encoder. It is not dependent on the expansion or contraction caused by the heat of the Linear Shaft Motor.

Applications

Lab Automation	Equipment Manufacturing	Medical/Biomedical	Other Automation
Microscope Automation Liquid Handling Robots Sample Handling Pick and Place Robotic Grippers	Laser Processing Welding/Heat Treating Engraving/Etching/Stamping Shaping/Grinding Electrical Discharge Machining Cutting/Punching Inspection Equipment	Pharmaceutical Packaging Automated Injecting Scanner Constant-Speed Drug Dispensing Medical Imaging	Industrial Sewing Machine Transfer Lines Semiconductor Equipment High-Precision Conveying Line-Head Drives in High-Speed Printers

Please visit nipponpulse.com/support for complete product specifications.

Motor Configurations

Hall Effect Sensors

The Linear Shaft Motor does not come with Hall effect sensors in its standard configuration; they will need to be selected as an option if required by your selected servo driver.

Hall effect sensors are devices able to sense position magnetically and provide this information to the servo driver. Some servo drivers require Hall sensor feedback for commutation. The Hall effect sensors are used by some servo drivers to obtain forcer position information relative to the shaft for commutation. Other servo drivers are able to obtain information for commutation from the linear encoder.

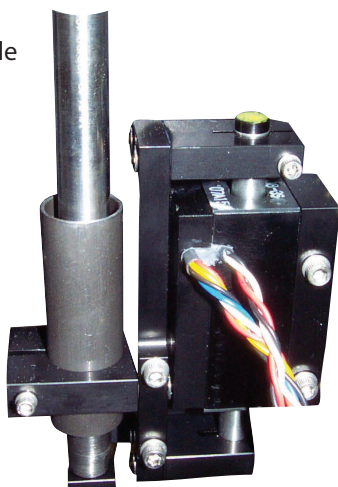

For most horizontal applications using servo drivers, there is no need for digital Hall effects. The commutation is based on a commutation table built during the tuning process, and is derived from the linear encoder. For most vertical applications, it is best to use digital Hall effects.

Because of the size of Hall effect sensors, they are not available on our 4mm Linear Shaft Motor. On the 8-20mm motors, the dimensions of your project must be expanded to include the sensors, which must be connected externally to the motor. On the 25mm series and larger, the sensors fit inside the motor and no additional space is needed in your design.

Cooling Methods

Although the Linear Shaft Motor inherently runs cooler than other linear motors, using heat dissipation can improve the ratings of the LSM by 30 to 40 percent. Cooling methods include, but are not limited to: heat routing, heat fins, heat fans, forced air, and water cooling.

Attached to a S080D, a 200mm x 100mm x 12mm heat sink improved the rated current by 75 percent. The same heat sink improved the rated current of a S160D by 30 percent.

Orientation Options

In a horizontal application, Linear Shaft Motors typically will have the load attached to the forcer so as to achieve simple and precise linear movements. The shaft is supported at both shaft supports, and the load moves along slide rails, linear bearings, or air bearings. A linear encoder scale is attached to the guide rails to provide position feedback for servo control.

In a vertical application, Linear Shaft Motors typically require a counterbalance mechanism, or brake, to prevent the load from dropping in the event of a power interruption. This can also reduce the net load on the motor by supporting it against gravity. Typical counterbalance techniques include a pneumatic cylinder, springs, or a counterweight.

Linear Shaft Motor in Parallel Systems

Parallel drive systems are any application that has two or more linear motors in parallel. In parallel applications, the wires extend from the shaft on opposite sides, whereas in non-parallel applications, other motor locations are not accounted for in the wiring.

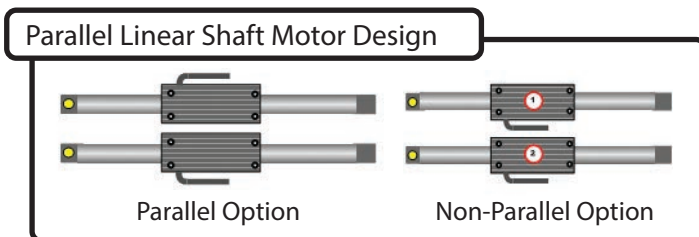

In high-precision, single-axis robot applications, truly accurate positioning is only possible when the feedback is directly in the center of mass of the work point. You also want your force generation from the motor directly in the center of mass of the work point, but you can't put both in the exact same location.

By putting an encoder in the center of mass, and using parallel Linear Shaft Motors equally spaced off the center of mass, you, in effect, are getting the desired feedback and force generation in the center of mass. You also are able to remove the heat source from the center of mass in high precision applications. This is impossible for other types of parallel drive systems, which require two sets of encoders and servo drives to provide this parallel drive functionality.

Drive Setup and Configuration Examples

Drive Systems for Linear Shaft Motor

Single Drive System

This is a basic drive system. The X and Y shafts can be used to create an X-Y stage.

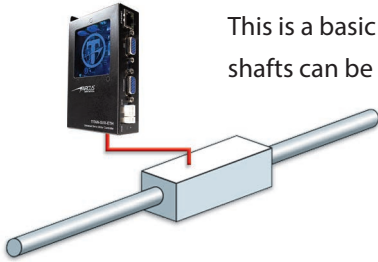

Tandem Drive System

Two or more forcers can be used on the same shaft to multiply the thrust.

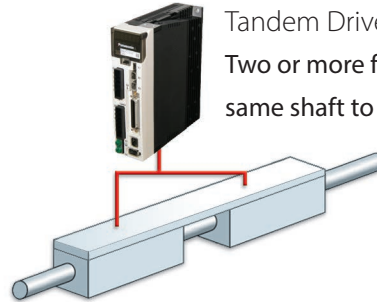

Multi-Drive System

Multiple forcers can be used with a single shaft to support complex movements required by some applications.

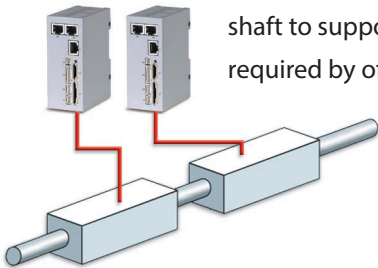

Parallel Drive System

Two or more forcers and two or more shafts connected to the same load can achieve large thrusts for moving heavy objects.

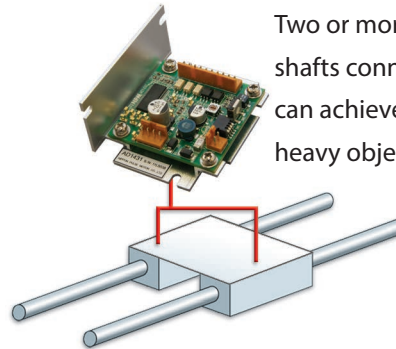

Allows for parallel drive using only one encoder and one driver

The mechanism must allow for 1-degree freedom of motion between the two motors.

Examples of Linear Shaft Motor Configurations and Axes of Movement

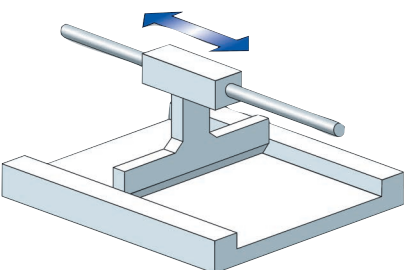
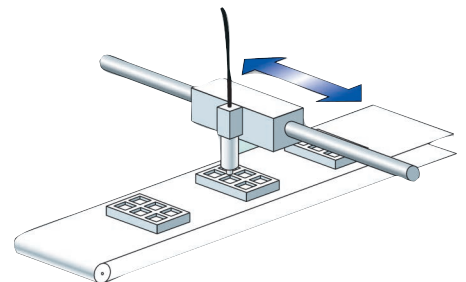
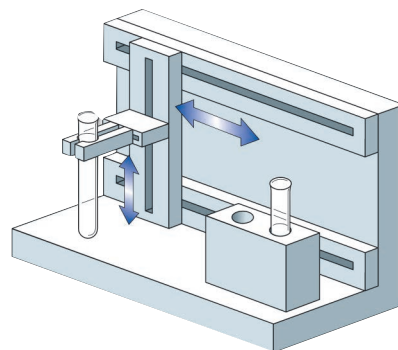
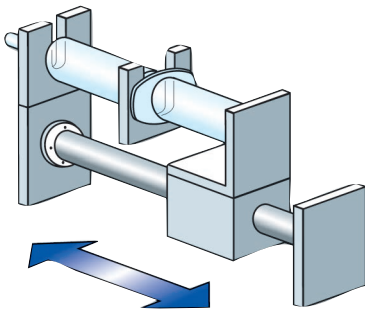
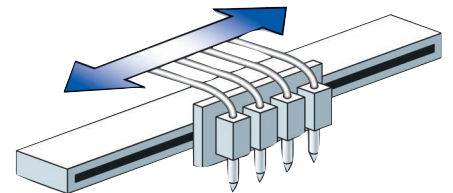
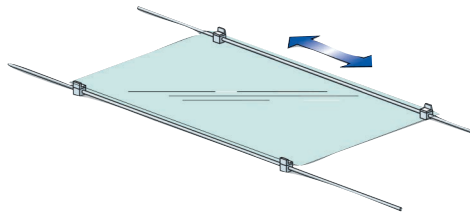
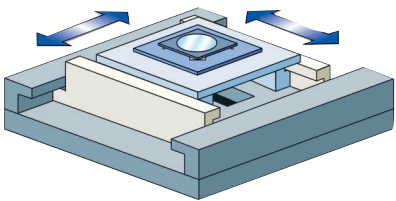

Fast and Slow Controllable Speeds — as fast as 15 meters/second and as slow as 8µm/second have been documented. Maximum shaft lengths of 6 meters.

Rotary Servomotors Overview

Micro Direct Drive Rotary AC Servomotors

Nippon Pulse's micro direct drive (MDD) rotary AC servomotors feature integrated high resolution incremental or absolute feedback devices in a compact unit, providing the ultimate accuracy and precision for positioning applications.

Features:

- Frame sizes between 13mm and 70mm, with each size available in three stack lengths
- Optional hollow shaft configuration
- Built-in absolute or incremental encoder for direct fine positioning
- Continuous torque 3.0 mNm to 1000 mNm, with peak ratings from 7 mNm to 3100 mNm
- Able to bear large loads directly due to high stiffness bearing
- Clean-room ready

Applications:

- Robotics
- Vision systems
- Semiconductor manufacturing
- Factory automation
- Inspection devices
- Smartphone testing equipment
- Haptics devices

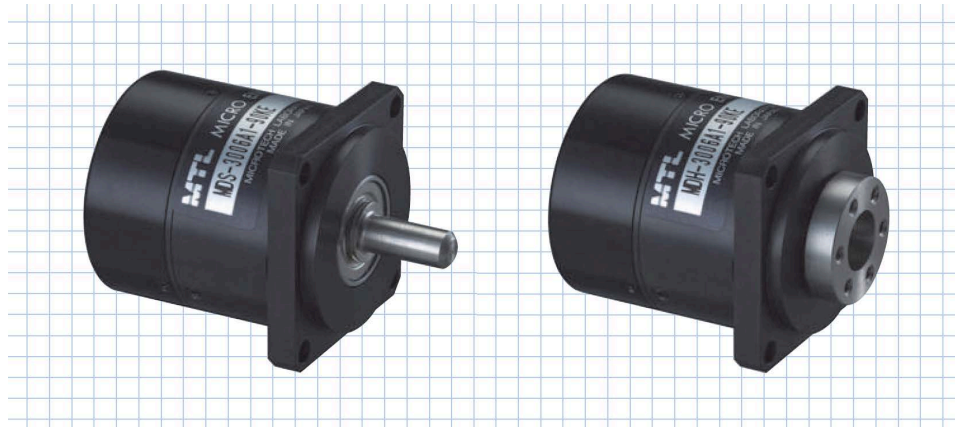

We are able to meet customer requirements with options for custom motor shafts and cable lengths, as well as various sealing options. All MDD motors are designed with optimized speed and torque characteristics, are both RoHS and CE compliant, and are available with Elmo and Panasonic drives.

Rotary Servo Part Numbering

MDS - 20 06
1 2 3

- 1: Series Designation
MDS: Standard
MDH: Hollow shaft
- 2: Body diameter (mm)
- 3: Stack length
06: Single
12: Double
18: Triple

ENGINEERING RESOURCES

ELECTRONICS

STAGES

SERVOMOTORS

STEPPER MOTORS

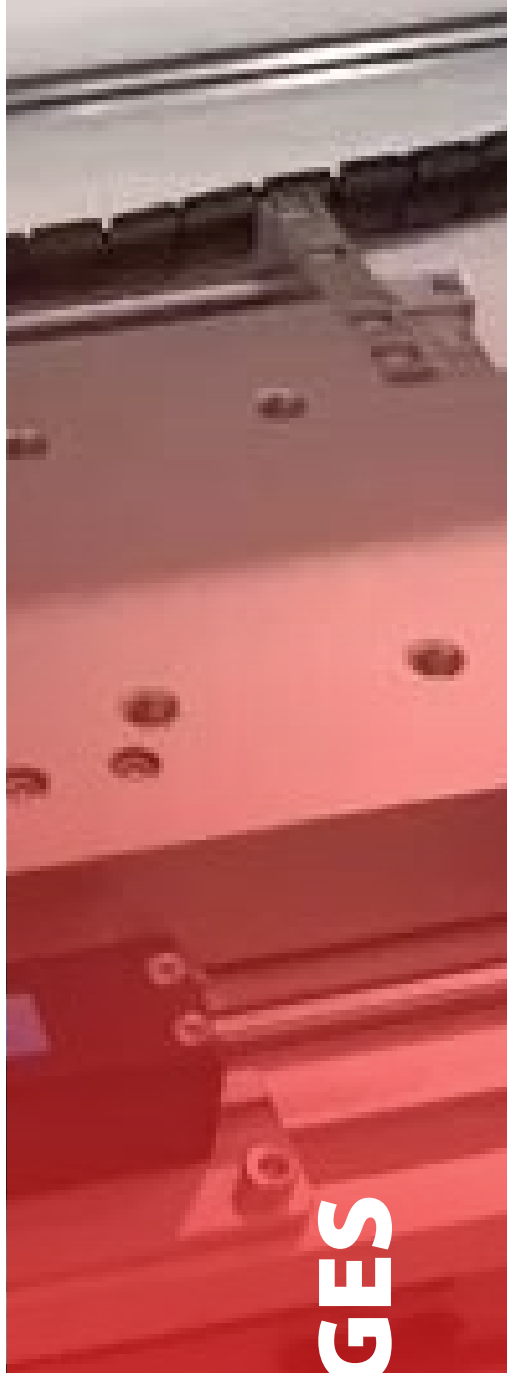
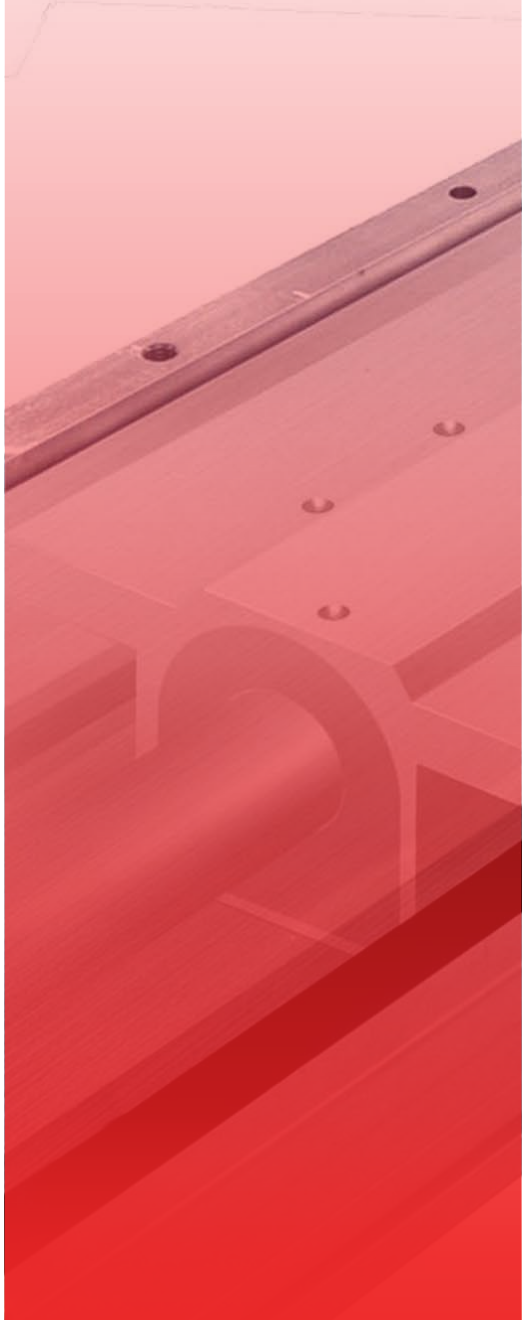

LINEAR STAGES

Linear Shaft Motors Integrated into Linear Stages

SCR and SLP Linear Stages

Nippon Pulse offers two types of linear stages – the Acculine SLP stages and Nanopositioning SCR stages – both of which are high-precision, single-axis linear stages. Both include an integrated Linear Shaft Motor and encoder (though the encoder resolution differs between the two series), and both are ideal for small-scale applications or applications with space limitations, due to their compact size. Both stage series provide the speed and performance expected of a servo stage.

What's the Difference?

The main consideration in selecting a stage will be the level of precision required for your application.

SCR stages include an optical linear encoder for sub-nanometer resolution, along with an integrated cross-roller guide and motor cables. This stage produces extremely accurate results with no loss in stability.

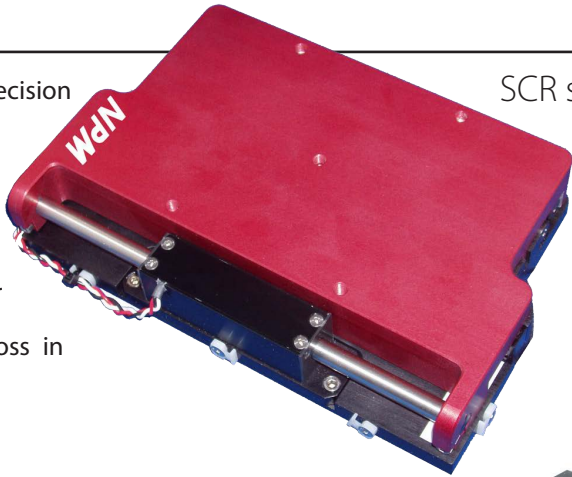

SCR stage

Meanwhile SLP stages include a 1-micron resolution encoder, along with integrated bearings and

Nippon Pulse SMART

Nippon Pulse offers the Linear Shaft Motor Application Resource Tool (SMART) to assist in determining the proper Linear Shaft Motor. SMART is available at nipponpulse.com. Now with relative price comparison!

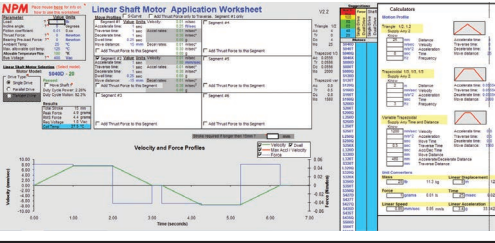

a linear guide. The SLP stages are perfect for simplifying the transition from ball-screw systems, and provide an unmatched force-to-volume ratio.



SLP stage

Check out our SMART tool to help you select the best size motor or stage for your application requirements!

Applications

Laboratory Automation	Optics/Photonics	Manufacturing	Other Automation
Microscope Automation Sample Movement Automated Work Stations MRI Pharmaceutical Packaging	Optical Scanners LCD Ultrasonic Scanning Imaging	Milling Machines Laser Cutter Semiconductor Equipment Inspection Machine Sorting Equipment Glass Processing Visual Inspection Laser Processing Bonding	Printing Machine Laser Printers Packaging Equipment Injection Molding Food Processing Electronic Discharge Machining

Please visit nipponpulse.com/support for complete product specifications.

SCR Nanopositioning Stages

High Precision Single-Axis Linear Stages

The SCR stage is a complete single-axis stage with an integrated slide guide, encoder and Linear Shaft Motor. It offers a wide range of advantages for applications requiring high performance and accuracy. The Linear Shaft Motor allows for higher resolution, speed, and continuous force than standard stepper or piezo servomotors.

Our SCR stages use standard 4, 8 and 16mm Linear Shaft Motors, though the coil windings are customizable to a double, triple or quadruple windings. These stages feature a moving magnet design, an integrated precision ground cross roller, and a built-in encoder.

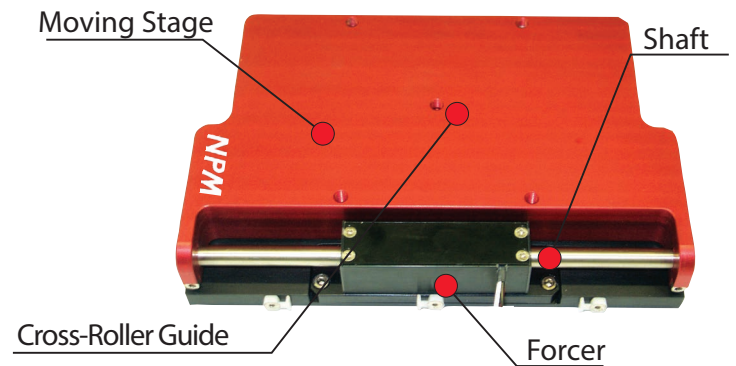

SCR Stage Advantages

- Accuracy of piezo driven stages with the high speed and high performance of servo stages
- Extremely accurate results with no loss in stability, regardless of the complexity of the motion profile
- Encoder resolution options from 1000nm to 5nm.
- Non-critical air gap allows for a system that does not have any variation in force generated
- Linear Shaft Motor provides large drive force thanks to efficient coil length
- Maintenance free and long lifespan! Non-contact motor design means no friction, so there is no sound or dust
- Stroke lengths from 20mm to 300mm, depending on model selected

Four SCR stage models for design flexibility in high-precision applications:



Application Example

SCR X-Y ARRANGEMENT

- Any two SCR stages will bolt directly together to form a very stiff, compact X-Y assembly, without the need for adaptor plates (provided they are in the same series). Two SCR stages in an X-Y stage orientation ensures true orthogonal orientation between the two axes.

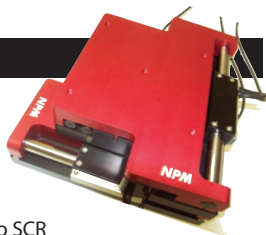

Note: All Nippon Pulse SCR and SLP stages require a servo driver in order to operate. Contact an applications engineer to assist in determining the best driver for your application.

Please visit nipponpulse.com/support for complete product specifications.

SLP Acculine Stages

High Performance Single-Axis Linear Stages

The SLP Acculine Series stage offers superior technology unmatched by any other linear stage system. SLP stages provide integrated shaft support within the housing, simplifying the transition from conventional linear motion systems such as ball-screws and pneumatic actuators. Because it features an integrated, lightweight, compact Linear Shaft Motor, the SLP is a low-profile, high-precision stage perfect for industrial applications or applications with space limitations.

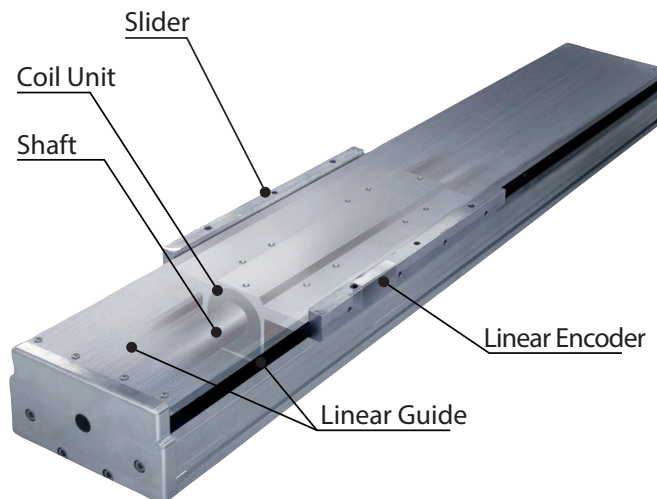

SLP Stage Advantages

- High thrust, high speed, high responsiveness, high precision
- Stroke lengths from 100mm to 2000mm, depending on model selected
- Simple design and easy installation
- Smallest deadzone of any stage system available on the market
- No competing stage matches the SLP series' force-to-volume ratio
- Maintenance free and long lifespan! Non-contact motor design means no friction, so there is no sound or dust

Three SLP stage models to meet your high-performance needs:



Application Examples

LOADER/UNLOADER

- Multiple sliders move independently with accuracy.
- Multi-sliders save space and cut costs.

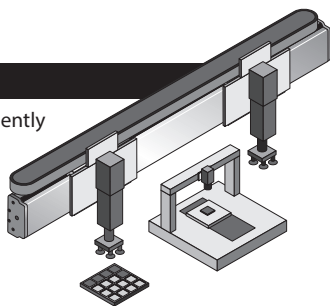

STANDARD X-Y ARRANGEMENT

- Due to the many ways the high-speed SLP15, SLP25 and SLP35 can be used together, a wide range of movement is possible.

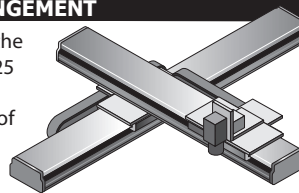

SUBSTRATE CONVEYANCE DEVICE

- By placing the lower shafts in a parallel position, it is possible to place the work in the central space.
- The shaft motors can be driven with one driver or in parallel motion.

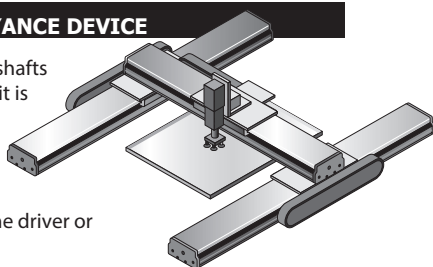

ORTHOGONAL JIG PLATE FOR X-Y TABLE

- When constructing a multiple-axis table using several SLP stage, installation is exceptionally easy with the placement of the jig plate between the axes, which can help you gain orthogonal precision between the lower and upper axes.
- Because there is a limit to the possible combinations for certain models, please ask an applications engineer about models suitable to multi-axis stages.
- Z-axis jig plates are also available for three-dimensional motion.

Please visit nipponpulse.com/support for complete product specifications.

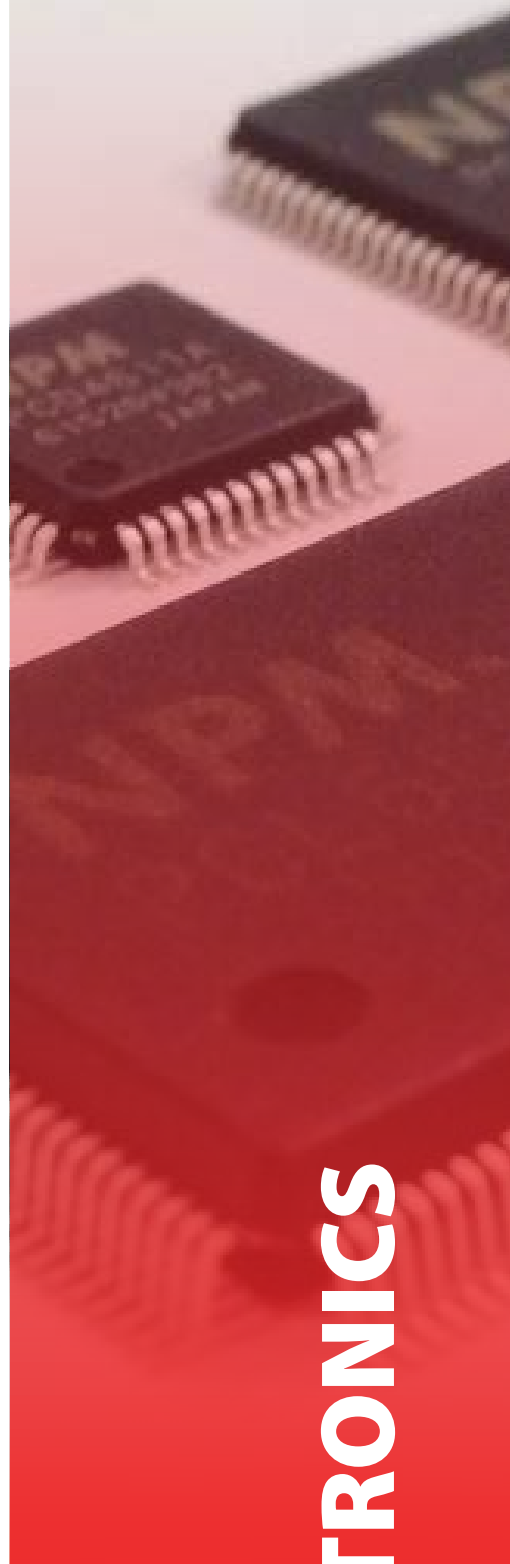
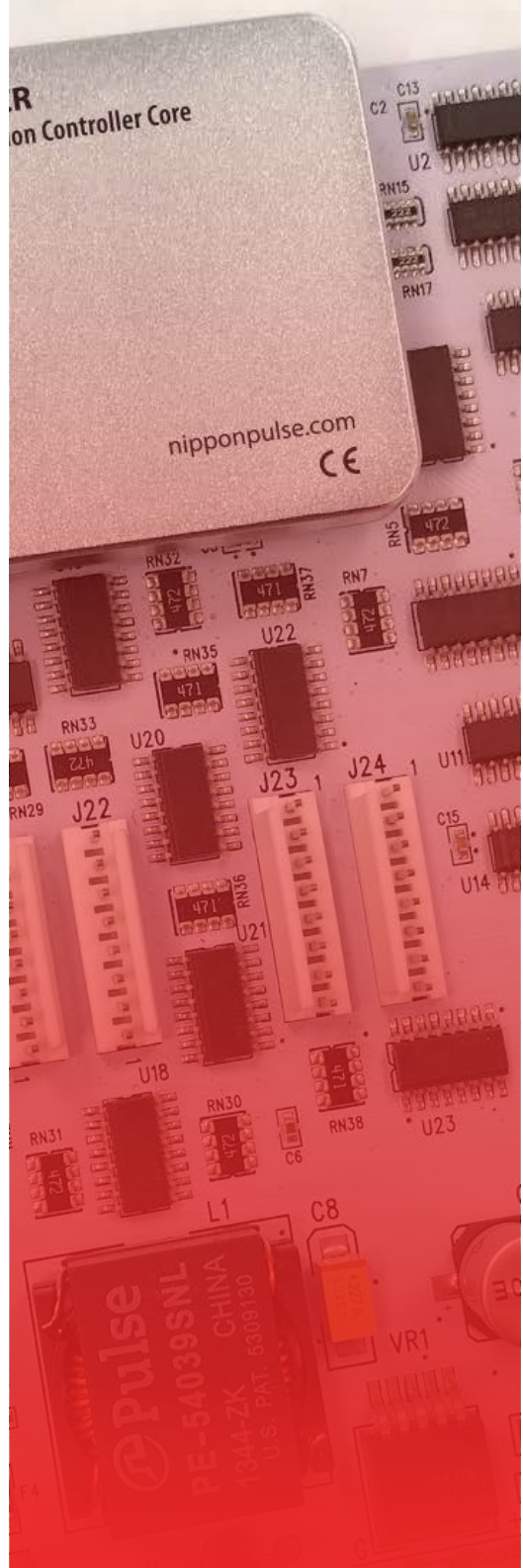
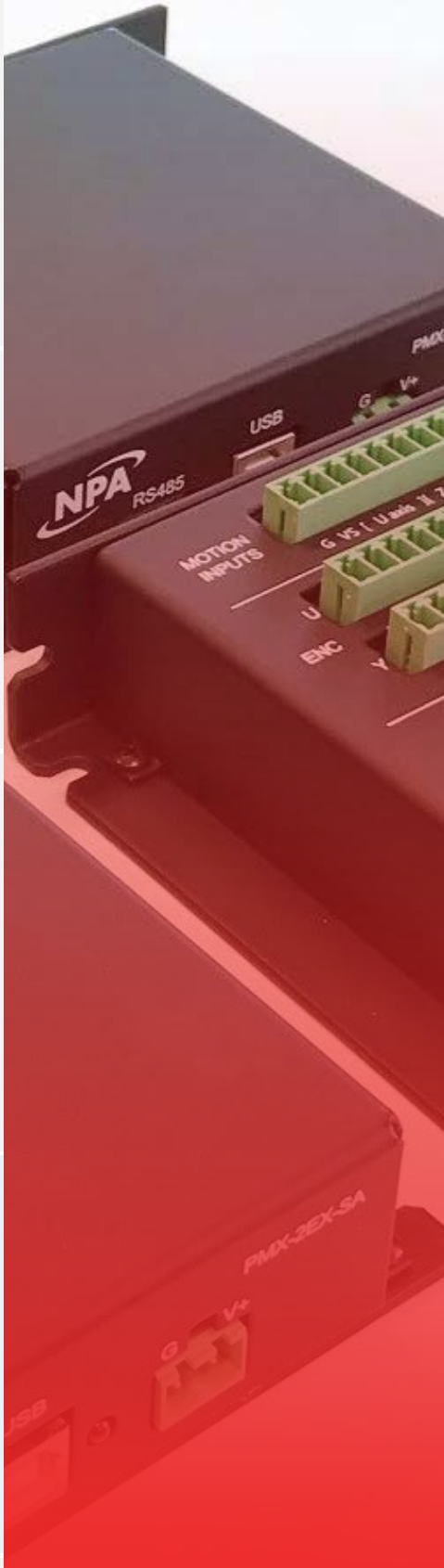

ELECTRONICS

Motion Control Electronics

More Options for Control

Whether control is needed for a simple point-to-point positioning application or for multi-axis interpolated moves, choosing the right motion controller can have lasting effects on the final product. A controller that doesn't have enough power or features to meet your motion control needs can adversely affect the performance and ability of your machine, while too robust a controller can add unnecessary cost into your system. Motion controllers range in size, type and capability.

Control Chips

A programmable pulse generator (ASIC, motion control IC) can control a stepper or servomotor by receiving commands from a CPU. The chip receives parameters for operating patterns from the CPU, and subsequently sends a START command. The motion profile can then be committed to the chip, reducing the burden to the CPU. First sold in 1985, our motion control chips are available with options for a variety of capabilities, including ultra-high-performance with interpolation functions, low-cost for simple motion control, and miniature versions.

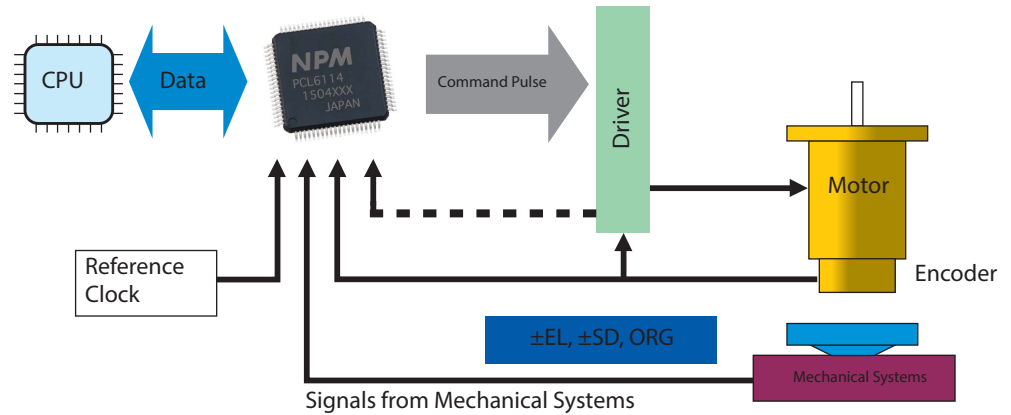

Control Boards

Nippon Pulse offers motion control boards for stepper motors and servomotors. These boards employ several different CPU interfaces and have features that fit different applications. Ready-built board units have already gone through the design-from-scratch process required when starting with an ASIC, and the firmware and circuit designs are fully vetted and ready to use.

Control Boxes

Our high-performance box controllers can control up to four axes of movement in a convenient all-in-one package. Ideal for applications such as robotics, laser cutting/engraving, and linear stage applications, including microscopes and scanners. Our box controllers allow for on-the-fly parameter adjustment, S-curve and trapezoidal motion profiles, and linear interpolation capabilities; the four-axis controllers are also capable of circular interpolation, and most can be operated via joystick.

Applications

Factory Automation	Semiconductor/Liquid Crystal Mfg.	Lab/Medical Equipment	Security & Office Automation
Injection molding machine	Exposure system	Blood analyzer	Security camera
Mounter	Membrane forming machine	Liquid injector	Entrance/exit management
Laser processing	Etching machine	CT scanner	Parking management machine
Winding machine	Washing machine	MRI apparatus	Industrial printer
Dispenser	Probing machine	Biopsy instrument	Labeling machine
X-Y stage	Dicing machine	X-ray generator	Card conveyor
Knitting machine	Bonding machine	Trial drug processor	Bank ATM
Paper processing	Molding machine	Pre-analysis processor	Sorting machine
Food processing machine	Appearance inspection instrument	Electronic microscope	Amusement equipment
Packaging machine	Dimension measuring instrument	Care & support instruments	House automation equipment
Automatic soldering machine	Liquid crystal processing		

Please visit nipponpulse.com/support for complete product specifications.

Calculations, Motion Profiles and Technical Overview

Typical Acceleration/Deceleration Patterns

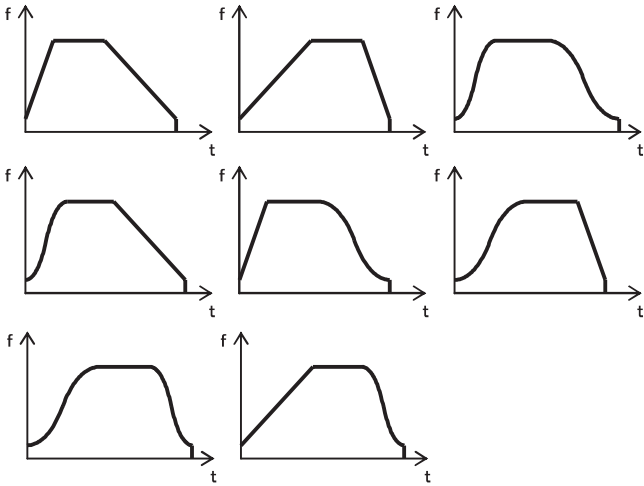

Interpolation

Controllers that provide linear interpolation enable interpolation in three dimensions. Models with circular and linear interpolation functions enable continuous circular-circular or linear-circular interpolation without pause.

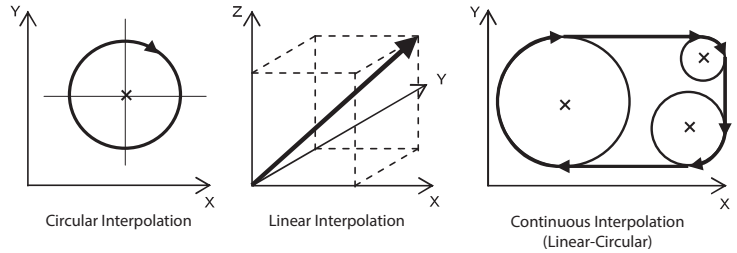

Pulsar Input/External Input

Receiving a signal from a manual pulser, the programmable pulse generator outputs to the driver, the pulse signal corresponding to the rotating amount, and speed designated by manual pulse signal. If required, the present position can be controlled using the up/down counter. To prevent the stepping motor from running out-of-step, the operating speed (output pulse rate) can be restricted.

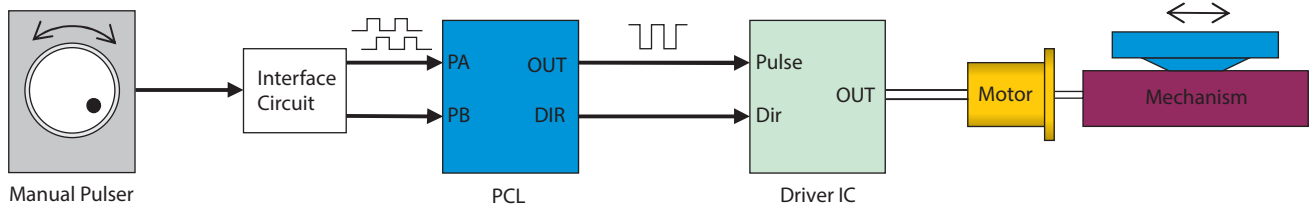

Overriding Target Position

Target position can be changed while operation is in progress.

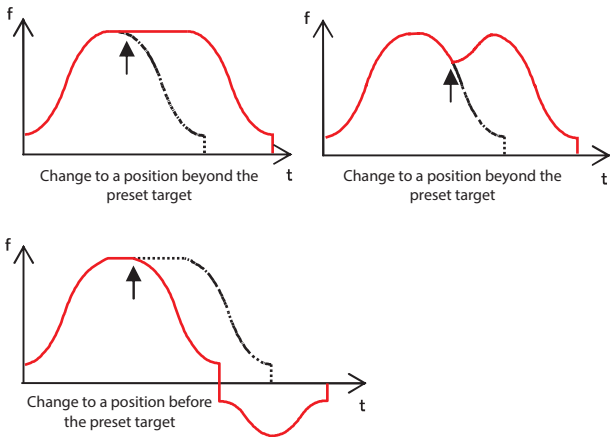

Changing Pulse Output Pattern During Operation (S-curve acceleration/deceleration)

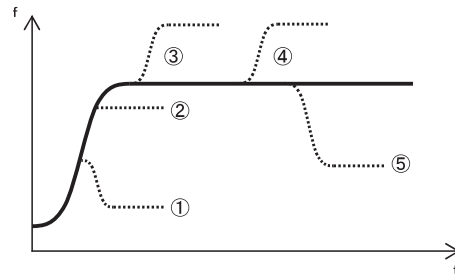

If the target speed is changed during the acceleration process and:

1. If the newly set value is lower than the current pulse rate at the time of the change, S-curve deceleration is made to the newly set value.
2. If the newly set value is equal to or higher than the current pulse rate at the time of the change, but less than the previous target, S-curve acceleration is made to the newly set value.
3. If the newly set value is greater than the previous target, S-curve acceleration is made to the preset pulse rate and then to the newly set value.

If the target speed changes while traveling at the previous target speed:

4. If the newly set value is higher than the preset FH register value, S-curve acceleration is made to the newly set value.
5. If the newly set value is lower than the preset FH register value, S-curve deceleration is made to the newly set value.

How to Determine Output Pulse Rate

$$\text{Output Pulse Rate} = \text{Pulse Rate Register Value} \times \text{Multiplication Register Value}$$

Example of S-curve acceleration/deceleration and S-curve section:

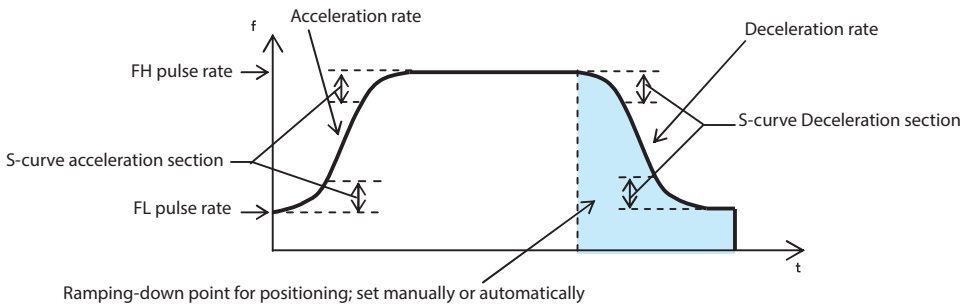

The higher the pulse rate register value, the finer the output pulse rate.

Note: With PCD46x1A series, S-curve acceleration/deceleration sections cannot be set, and the deceleration rate is the same as the acceleration rate.

Typical Operation Profiles

Preset Operation (Positioning)

The chip stops generation of pulses upon outputting a preset number of pulses.

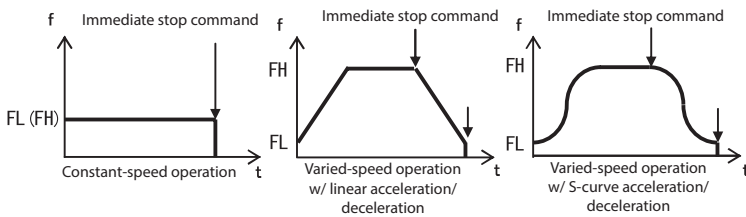

Immediate Stop

Immediate stop command stops the chip from outputting pulses regardless of operating status.

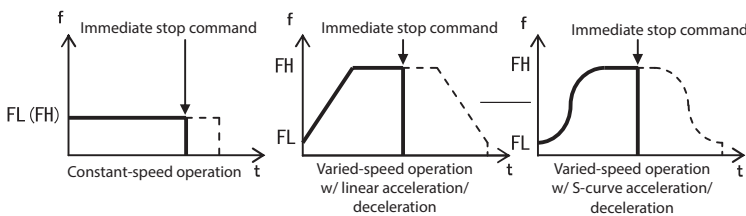

Deceleration Stop

Deceleration stop command lets the chip decelerate the pulse output and stop upon decelerating to the starting pulse rate.

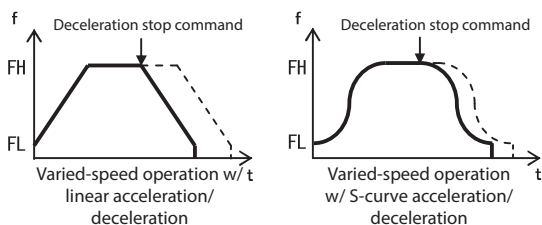

Origin Return/Homing

Origin return sequence can be programmed using origin signal (ORG) ramping-down process signal (SD), end limit signal (EL) and encoder Z-phase signal. Listed below are typical origin return sequences in varied-speed operation.

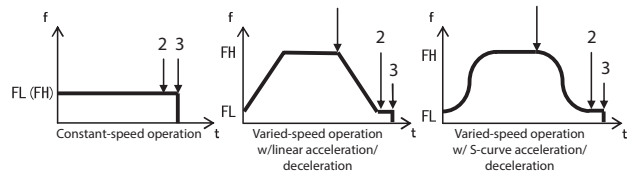

1. SD signal ON starts deceleration (1), and ORG signal ON stops pulse output (3).
2. SD signal ON starts Z-phase signal counting (2), and completion of counting stops pulse output (3).
3. ORG signal ON starts deceleration (1), and pulse rate output stops when decelerated to the FL pulse rate (3).
4. ORG signal ON starts deceleration and Z-phase signal counting (1), and completion of counting stops pulse output (3). PCL6000 series provides many other origin return sequences including those using EL signal. With PCD46x1A series, only the first and third sequences are applicable.

Triangular Drive Correction Function

When positioning and movement are minimal, this function automatically lowers the operating pulse rate (FH), thereby eliminating triangular drive for a smooth pulse rate curve.

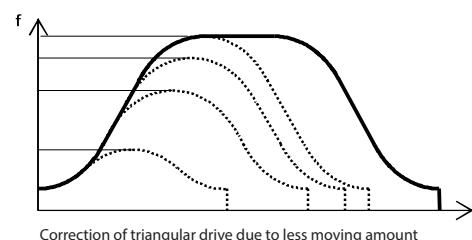

Correction of triangular drive due to less moving amount

Chip-Level Controllers

Motion controls that are designed from scratch are ideal for OEMs that typically build controllers in large quantities. Starting from the ASIC and building from there allows OEMs to customize their controllers with the specific features used by their equipment, driving the component count and cost down. With fully tested and ready to go firmware, our motion control chips boast a long lifespan.

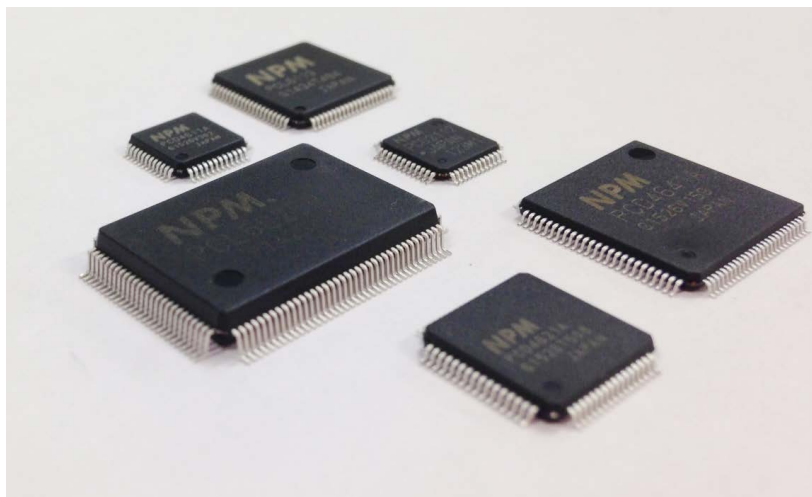

Advanced Motion Controllers

PCL61xx series, PCL60xx series

The Most Advanced Controller Chips in the World! Our PCL family is ideal for stepper or servo applications, and includes options for 1, 2 and 4 axes of movement. Advanced functions in these series include linear/circular interpolation, and pre-registers for continuous circular-to-linear-to-circular interpolation. Other features include: overriding operating pulse rate and target position during operation, suppression of vibration at cessation, servomotor interface and more. Easily configure a complicated motion control system.

Economical Stepper Controllers

PCD46xx series

Low-cost, programmable pulse generators equipped with an excitation sequence generator circuit to drive two-phase stepper motors. Placing a stepper motor drive IC between the PCD and each stepper motor enables the user to easily configure a multi-axial motion control system. Each model can also output a pulse train.

Miniature Servo/Stepper Controller with SPI

PCD21xx chip

The first of its kind, this miniature package (mold measuring only 7x7mm) adopts a four-wire serial bus that enables downsizing of the board. It can output two-phase stepping motor excitation sequence and is equipped with a servomotor interface. Ideal for customers who want to make the motion control board smaller, operate the chip as a standalone unit without a CPU connected, or intelligently control a motor with a CPU with fewer pins.

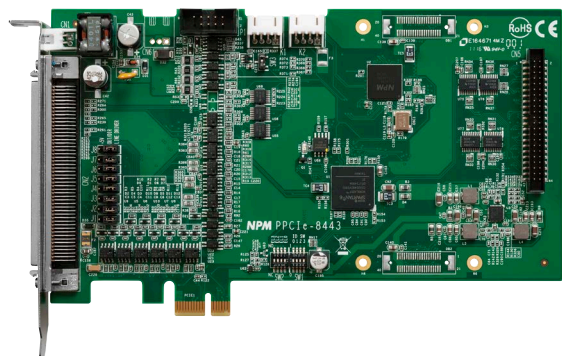

Board-Level Controllers

Board-level controllers are ideal for customers who want a controller that is ready to use and simple to program, with standard programming options and communication interfaces. All of our control boards have integrated Nippon Pulse controller chips, so OEMs get all the benefits of our ASIC controllers, with the added benefit of reduced design time. We offer both stepper and servo controller boards, with plenty of advanced control options available.

Powerful Controllers with Advanced Features

PPCI / PCIe boards, NPMC board

Three of our boards are equipped with our most powerful PCL60xx series ASIC controllers for servo or stepper control. Each utilizes a different serial communication configuration, and all are capable of up to four axes of control, speed and positioning changes "on the fly," and software for easy setup. Options for combining boards for up to 48-axis control!

Compact Board for Simple Stepper Control

FMC board

Our smallest controller board is equipped with a PCD21xx chip for single-axis control. It contains a 2-phase stepper driver, and can register up to 32 pattern operations and 256 steps of execution sequence program in its internal memory, and automatically processes them in sequence without connecting to a PC. Save operation patterns and programs!

Please visit nipponpulse.com/support for complete product specifications.

Box-Level Controllers

Nippon Pulse's box controllers provide a turnkey, all-in-one control solution. Ideal for applications such as robotics, laser cutting/engraving, and linear stage applications, including microscopes and scanners. Our box controllers include integrated pre-designed boards and ASICs, which allow fewer opportunities for customization, but offer wide functionality for OEMs that want to "plug and play." Among many other features, all of our box controllers allow for on-the-fly parameter adjustment, S-curve and trapezoidal motion profiles, and linear interpolation capabilities.



Coordinated-Motion Controllers

PMX series

PMX box controllers utilize PCL60xx series advanced motion controller chips for 4-axis and 2-axis motion. The PMX series also features linear coordinated motion capabilities (as well as circular coordinated motion capabilities for four-axis models). More available functions include encoder feedback support, multi-task standalone programming, and analog joystick control, to name just a few. These box controllers are available with USB, RS-485 and Ethernet communication options, and are easy to set up and run. The 2-axis model also includes two microstep drivers.

Please visit nipponpulse.com/support for complete product specifications.

Commander Core for Custom Solutions

The all-new Commander core is a motion controller module that combines all the benefits of ready-built, off-the-shelf controllers with the customization of design-from-scratch ASIC controllers. Flexible, secure and easy to use, this powerful hybrid IC is a new, innovative design built around our PCL60xx ASIC, our most advanced controller chip series.

Four-Axis Commander Core

The Commander core is a hybrid IC designed to be a very powerful and flexible motion controller. It provides ease of use for engineers, as it reduces from-scratch design time and requires minimal support to quickly prove out system programs and designs. It is also cost-effective for an OEM to take the Commander

core to higher volume production, integrated into their final custom PCB design. The Commander core eliminates the need to source components from additional suppliers, and therefore the Commander core's design isn't dependent on the lifespan of the original components.

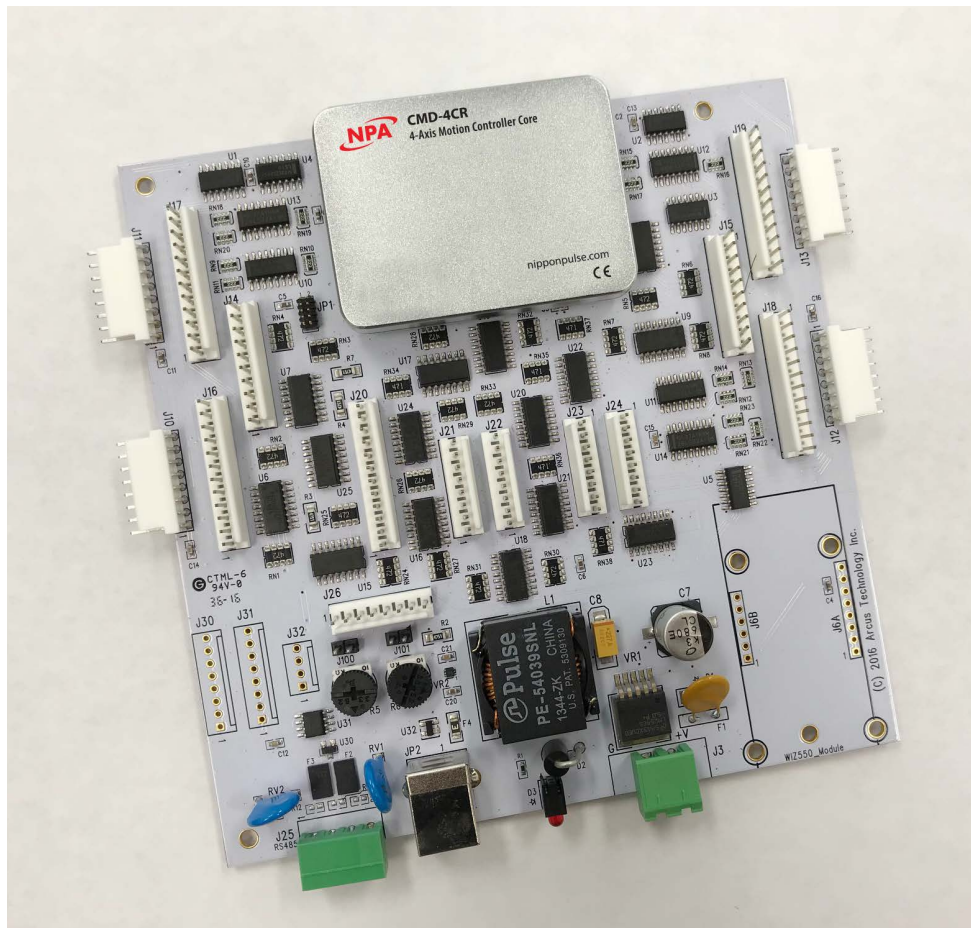

Commander Development Kit
The Commander development kit utilizes the Commander core for easy-to-use four-axis motion control. The development kit includes a full software package. Reduce development time and investment with the Commander development kit.

Please visit nipponpulse.com/support for complete product specifications.

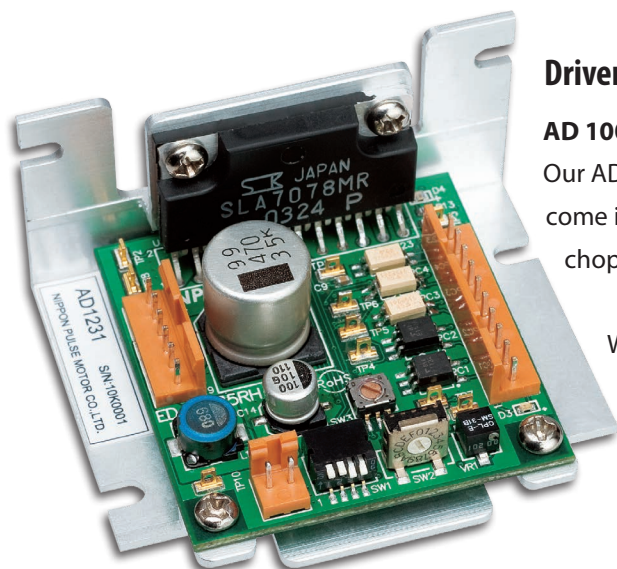

Driver Boards

AD 1000 series

Our AD Series of 2-phase stepper motor drivers are single-axis drivers that come in constant voltage varieties for unipolar motors or constant current chopper drivers for unipolar or bipolar motors.

With advanced features like automatic current reducers and opto-isolated inputs, our AD series drivers represent the cutting edge of stepper motor electronics.

Custom PCB Design

We can custom-design a motion control PCBA for your unique application, utilizing Commander core (CMD-4CR) and stepper/servo/BLDC/voicecoil drivers for multi-axis movement. Streamline your application, reduce cabling and cost, and ramp up production! Manufactured to your specifications. Contact us for more information.

Before:



After:



Other Electronics (Distributor)

Nippon Pulse is also a re-seller of controller and driver electronics from a variety of other premier motion control manufacturers for servomotor and stepper motor control. Please visit our website for more information, or contact an applications engineer to determine what electronics would be the best fit for your application.

Please visit nipponpulse.com/support for complete product specifications.

STEPPER MOTORS

$$+ (J_2 + J_3) \left(\frac{N_1}{N_2} \right)$$

SERVOMOTORS

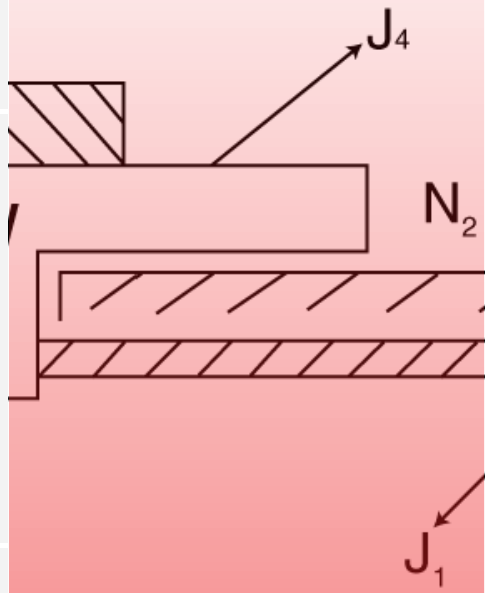

STAGES

$$= \frac{W}{981} \left(\frac{\delta}{\frac{\pi}{180} \cdot \alpha} \right)$$

$$J_4 = \frac{W}{981} \left(\frac{P}{2\pi} \cdot \frac{N_1}{N_2} \right)$$

ELECTRONICS

$$x \frac{r^2}{2} = \frac{\pi r^2 \cdot L \cdot \rho}{981 \times 2}$$

ENGINEERING RESOURCES

Heat °C Over	100
80	
60	
40	
20	
Motors	
S040D	
S040T	
S040Q	
S040X	
S080D	
S080T	
S080Q	
S120D	
S120T	
S120Q	
S160D	
S160T	
S160Q	
S200D	
S200T	
S200Q	
L250D	
S250D	
S250T	
L250Q	
S250Q	
S250X	
L320D	
S320D	
L320T	
S320T	
L320Q	
S320Q	
S320X	
S350D	
S350T	
S350Q	
S427D	
S427T	

Heat °C Over	Forcer	Shaft
100	Single Drive	Single Drive
80	Dual Drive	Dual Drive
60		
40		
20		

1/2.2
1/2
4
0
4
25
pezoid 1/3
0.0556
0.0556
0.0556
2000
pezoid var
0.8
0.5
0.8
1560

Triangular Profile
1/2
1/2

Have	X (m)	V (m/sec)
olve For	T (sec)	T (sec)
Distance X(m)		X = (1/2) * V * T
Velocity V (m/sec)	V = 2 * (X/T)	
Acceleration A (m/sec ²)	A = 4 * (X/T ²)	A = 2 * (V/T)

Trapezoidal Profile
1/3
1/3
1/3

Have	X (m)	V (m/sec)
olve For	T (sec)	T (sec)
Distance X(m)		X = (2/3) * V * T
Velocity V (m/sec)	V = 1.5 * (X/T)	
Acceleration A (m/sec ²)	A = 4.5 * (X/T ²)	A = 3 * (V/T)

Variable Trapezoidal Profile

(Formulas listed below are for calculating acceleration and deceleration)

ENGINEERING RESOURCES

Stepper Motor Evaluation Testing Kits

Nippon Pulse has made it simple for you to test your application and get it up and running. Simply choose the proper motor, controller and driver for your application needs to get started. Follow the simple steps below, or contact one of our applications engineers for assistance.

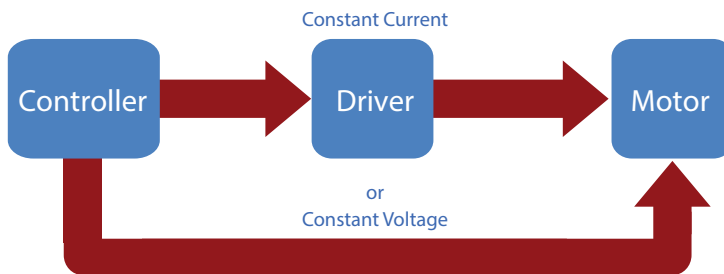

Step 1: Pick your controller.

- **Control Board:** Single-axis or four-axis controller options for simple or advanced motion control operations. Can be integrated into the electronics for your final application design.
- **Controller Box:** Two-axis or four-axis motor control for “plug and play” functionality.

Step 2: Select the proper driver for your application and motor.

If using a controller with a built-in driver, you only need an external driver if the built-in driver on these controllers doesn't meet your needs. A driver is necessary for Constant Current applications, but not for Constant Voltage applications.

Step 3: Pick your motor.

Which series, size and type of motor do you require? You can use this evaluation kit to test any of our tin-can, Linearstep, linear hybrid or hybrid stepper motors. Choose the standard motor and size that is the closest fit for your application; if you are interested in customizing a motor or receiving a fully custom design, contact one of our applications engineers to learn more about our capabilities and pricing.

Step 4: Contact Nippon Pulse to receive your prototype motor and evaluation testing kit.

Our kit allows you to test the motor, controller and driver in your application to ensure a perfect fit before placing a larger order.

info@nipponpulse.com | 1-540-633-1677

Contact one of our applications engineers to discuss your selections or receive assistance in making a selection.

Commander Development Kit

Nippon Pulse's Commander core is available as part of a development kit for four-axis servo or stepper control. The kit comes equipped with the Commander core, the Commander development board, and all required cables and software.

Contact our applications engineers to learn more.

Formulas for Stepper Motor Selection

A stepper motor should provide an output torque larger than load torque and be required to start and stop at a proper step rate against load inertia. Also, while operating the motor at a rate higher than the starting pulse rate, the rate needs to be varied within a proper acceleration time. Here are some basic formulas to help you determine the torque, inertia and acceleration/deceleration time you require of the stepper motor to fit your application.

Obtaining Load Inertia

$$= \frac{Mr^2}{2} = \frac{W}{g} \times \frac{r^2}{2} = \frac{\pi r^2 \cdot L \cdot \rho \cdot r^2}{981 \times 2} = \frac{\pi \cdot \rho \cdot Lr^4}{1962}$$

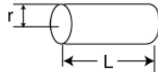

where:

- J = Load inertia (kg · cm · s²)
- π = Ratio of the circumference of a circle to its diameter (3.14)
- ρ = Specific gravity of cylinder material (kg/cm³)
(Iron = 7.8 x 10⁻³, Aluminum = 2.7 x 10⁻³)
- L = Length of cylinder (cm)
- r = Radius (cm)
- g = Gravitational acceleration 981 (cm · s⁻²)
- M = Mass
- W = Weight

$$J = 2 \times J_1 + J_2 = 2 \left(\frac{\pi \rho L r^4}{1962} \right) + \frac{W r^2}{981}$$

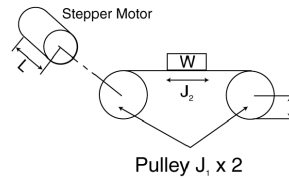

where:

- J = Load inertia (kg · cm · s²)
- J₁ = Inertia of pulley (kg · cm · s²)
- J₂ = Inertia of linear movement (kg · cm · s²)
- W = Weight of belt and material (kg)
- r = Radius of pulley (cm)
- L = Length (cm)
- ρ = Specific gravity of cylinder material (kg/cm³)
(Iron = 7.8 x 10⁻³, Aluminum = 2.7 x 10⁻³)

where:

- J = Load inertia (kg · cm · s²)
- J₁ = Inertia of pulley (kg · cm · s²)
- J₂ = Inertia of take-up (kg · cm · s²)
- W = Weight of material to be wound (kg)
- r = Radius of pulley (cm)
- ρ = Specific gravity of cylinder material (kg/cm³)
(Iron = 7.8 x 10⁻³, Aluminum = 2.7 x 10⁻³)

$$J = J_1 + J_2 = \frac{\pi \rho \cdot L \cdot r^4}{1962} + \frac{W r^2}{981}$$

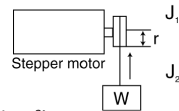

where:

- J₀ = Load inertia (kg · cm · s²)
- J₁ = Inertia of pinion (kg · cm · s²)
- J₂ = Inertia of gear (kg · cm · s²)
- J₃ = Inertia of feed screw (kg · cm · s²)
- J₄ = Inertia of work and table (kg · cm · s²)
- N₁ = Number of pinion teeth
- N₂ = Number of gear teeth
- W = Weight of work and table (kg)
- π = Ratio of the circumference of a circle to its diameter (3.14)
- α = Step angle per pulse (°)
- δ = Table movement per pulse (cm)
- P = Pitch of feed screw (cm)

$$J_0 = J_1 + (J_2 + J_3) \left(\frac{N_1}{N_2} \right)^2 + J_4$$

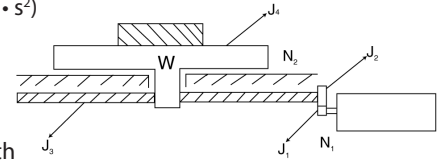

$$J_1 = \frac{W}{981} \left(\frac{\delta}{\frac{\pi}{180} \cdot \alpha} \right)^2$$

$$\text{or } J_1 = \frac{W}{981} \left(\frac{P}{2\pi} \cdot \frac{N_1}{N_2} \right)^2$$

Obtaining Load Torque

$$T = F \times r$$

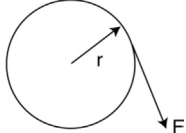

where:

- T = Load torque (kg · cm)
- F = Force to rotate the coupling shaft of a stepper motor (cm)
- r = Radius to apply the force (F) (cm)

where:

- T = Load torque (kg · cm)
- N₁ = Number of pinion teeth
- N₂ = Number of gear teeth
- W = Weight of table and work (kg)
- F = Cutting resistance (kg)
- μ = Frictional resistance of rubbing surface
- P = Pitch of feed screw (cm)
- η = Transfer efficiency of the system including feed screw and gear

$$T = \frac{N_1}{N_2} \times \frac{(F + \mu W)P}{2\pi\eta}$$

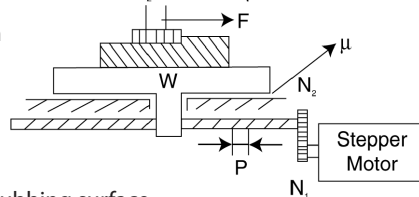

Calculating Output Torque From Gearhead

$$T_{gh} = T_m \times G_r \times 0.85^n$$

where:

- T_{gh} = Torque from Gearhead
- T_m = Torque from motor
- G_r = Gearhead ratio (# of times motor turns per 1 turn of gearhead)
example: 1/3 gearhead G_r = 3
- n = Number of gears

Linear Shaft Motor Selection Guide

One of the most straight-forward tasks in the design of a linear motion system is to specify a motor and drive combination that can provide the force, speed and acceleration required. This is often the most overlooked aspect of the linear motion system design, making the motor the most costly part of the system, not only in the initial cost, but also in relation to service maintenance and energy.

The unique properties of the Linear Shaft Motor make its sizing for applications slightly different than that of other linear motors. Nevertheless, the proper sizing of a Linear Shaft Motor is rather straight-forward. Nippon Pulse provides the **SMART** sizing software to assist in the selection of a proper motor and drive combination for your mechanical design. Please use the following chart to assist in organizing the operation conditions for your system.

Item	Symbol	Unit	Notes	Examples
Load mass	M_L	kg	Mass of the moving part of your system less the mass of the motor.	Example: Table, Encoder
Load (thrust) Force	F_L	N	Thrust Force is added to all segments of the motion profile. This is in addition to force needed to overcome mass, acceleration and friction.	Example: As the motor moves, it needs to maintain 10 lbs of force on an object.
Run (pre-load) Friction	F_r	N	Pre-load Force is considered in all moving segments of the motion profile. Keep in mind all external forces that disturb the movement.	Example: Cable Chain, Bearing wipers, Preloaded Guide, springs
Moving Motor Mass	M_c	kg	If you are not sure which motor you are going to need, start with a value of 1/10 of load mass.	
Friction coefficient	μ			
Incline Angle	α	°	0° is Horizontal while 90° is Vertical	
Available Voltage	V	Vac		
Available Current	A	Arms		
Max Allowable temperature		°C		

Next, define what movements your system will be making using the following chart for assistance:

Item	Symbol	Unit	Notes
Stroke	X	mm	<p>Note: This application note walks you through sizing with only one segment. It is recommended for the best sizing of a Linear Shaft Motor, a complete cycle should be used for sizing. Stroke out and back. The SMART sizing software allows for sizing with up to six segments.</p>
Velocity	V	m/s	
Acceleration time	T_a	s	
Continuous time	T_c	s	
Deceleration time	T_d	s	
Settling time	T_s	s	
Waiting time	T_w	s	

Selection Flow:

- 1. Calculations for Load Condition**
The chart shown here helps to calculate a load force. The frictional load of the linear guide and the resistance force of the cable carrier (FC) are run friction and treated as pre-load force. For your initial calculations, it is suggested you use 1/10 the load mass, as the value for Forcer mass (MC).
- 2. Calculations for Required Thrust** - You will need to calculate a thrust value for each section of the motion profile. In these equations, "μ" is the coefficient of friction on the guide. "g" is as the acceleration of gravity. $g = 9.81 \text{ m/sec}^2$. "α" is the angle of incline. For vertical or incline moves use F_r for moves against gravity and F_{rd} for moves with gravity.
- 3. Temporary Selection** - The largest thrust value calculated in section 2, must be less than peak thrust of the selected Linear Shaft Motor. It is good practice to add 20 to 50% to the peak thrust as a safety margin. Please note that the peak thrust of the Linear Shaft Motor may vary with operation speed.
- 4. Confirm MC** (forcer mass) is smaller than the value used in section 1. If it is larger, please return to section 1 to recalculate using the new MC value.
- 5. Confirm Effective thrust (F_{eff})** - Please confirm that effective force (F_{eff}) is less than the continuous rated force (F_{rated}) of the motor plus a safety factor (SF) of 30% to 50%.
- 6. If the effective force (F_{eff})** is larger, please select a new motor where the rated force (F_{rated}) is met in the equation.

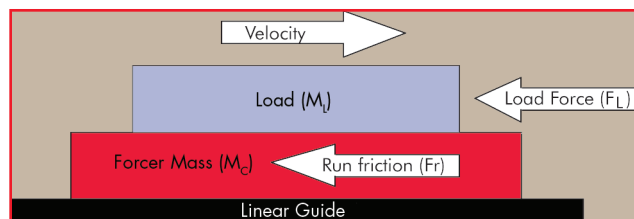

F_1	Force (Inertia)	$F_1 = (M_L + M_c) * (V / T_a)$	
F_f	Force (Friction)	$F_f = (M_L + M_c) * g * [\sin(\alpha) + \mu * \cos(\alpha)] + F_r$	
F_{fd}	Force (Friction) down	$F_{fd} = (M_L + M_c) * g * [\sin(\alpha) + \mu * \cos(\alpha) * -1] + F_r$	
F_1	Acceleration force	$F_1 = F_i + F_L + F_r$	Inertia force + external force
F_2	Constant velocity force	$F_2 = F_L + F_f$	load of external force
F_3	Deceleration force	$F_3 = F_i - (F_L + Fr)$	inertia force - external force
F_4	Dwell force	$F_4 = (M_L + M_c) * g * [\sin(\alpha)] + FL$	

$$F_{eff} = \sqrt{\frac{(F_1^2 * T_a) + (F_2^2 * T_c) + (F_3^2 * T_d)}{(T_a + T_c + T_d + T_s + T_w)}} < SF_{rated} + SF$$

Useful Formulas for Common Motion Profiles

Common Motion Profile Formulas

Triangular Profile 1/2, 1/2

Accelerate to speed and decelerate back to original speed or zero, rest and repeat the process as needed. This is very simple and is common in applications such as pick & place.

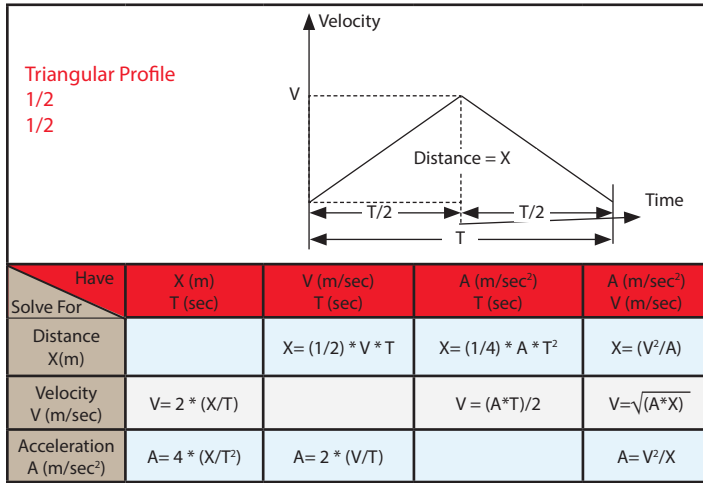

Trapezoidal Profile

Accelerate to constant speed, travel at that constant speed, and then decelerate back to original speed of zero. This is common in applications such as scanning inspection. There are two types, the 1/3 Trapezoidal Profile and the Variable Trapezoidal Profile.

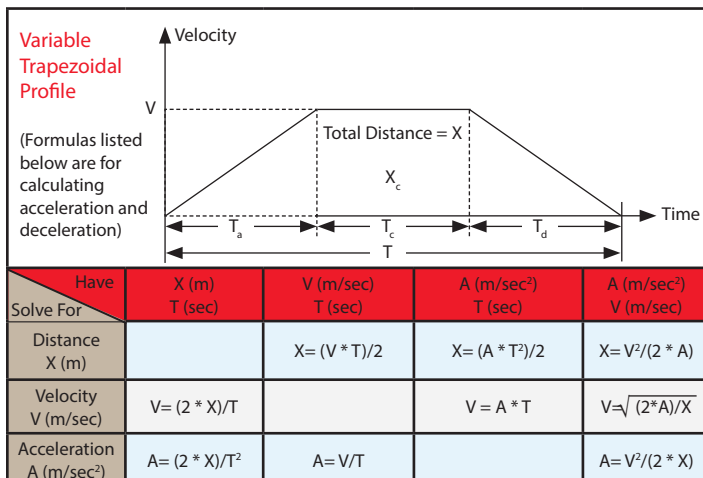
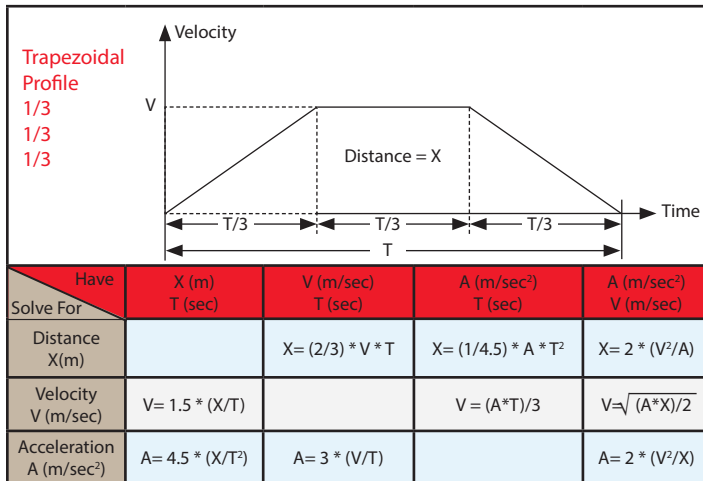

Useful Formulas

General Formulas

Acceleration G $ACCG = A (m/sec^2)/9.81$
 Gravity $g = 9.81$
 Friction Coefficient $(FC) = M2/M1$, M1 being the mass of the load to be moved, and M2 being the amount of force required to move the mass.

Voltage $V = I * R$
 Current $I = V/R$
 Resistance $R = V/I$

Voltage and Current RMS vs. Peak

RMS (AC) $Peak * 0.707$
 Peak (DC) $RMS * 1.414$

Examples:

	Voltage	Resistance	Current
Peak Values	5	25	0.2
RMS Values	3.535	25	0.1414

Please ensure your units remain constant when calculating RMS or Peak Values.

Encoder Formulas

Encoder Resolution $Er = \frac{Scale\ Pitch}{(4 * Interpolation)}$

Enc. Output Freq. (A-B Phase) $E_{OF} = \frac{Velocity * 10^6}{(4 * Encoder\ Resolution)}$

Enc. Output Freq. (Sine-Cosine) $E_{OF} = \frac{Velocity * 10^6}{(Scale\ Pitch)}$

Amplifier/Driver Sizing Formulas

Voltage due to Back EMF $V_{BEMF} = Back\ EMF * Velocity$

Voltage due to R * I $V_{ri} = 1.225 * Resistance * Peak\ Current$

Voltage due to Inductance $V_L = \frac{7.695 * Velocity * Inductance * Peak\ Current}{Magnetic\ Pitch}$

Min. Bus Voltage needed $V_{bus} = 1.15 * \sqrt{[(V_{bemf} + V_{ri})^2 + V_L^2]}$

Peak Current (rms value) $I_{prms} = Peak\ Current * 1.2$

Continuous Current (rms value) $I_{Crms} = Continuous\ Current * 1.2$

These formulas add a 20 percent safety margin for current and a 15 percent safety margin for voltage.

Nippon Pulse SMART (Shaft Motor Application Resource Tool)

Nippon Pulse offers the Linear Shaft Motor Application Resource Tool (SMART) to assist in determining the proper Linear Shaft Motor. It requires Microsoft Excel 98 or newer. SMART is part of the LSM design toolkit available at nipponpulse.com. Now with relative price comparison!

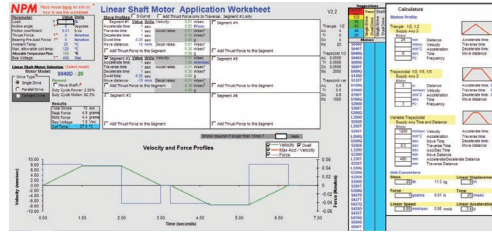

Motor Sizing Example

See below for an example of how to size a Linear Shaft Motor. You can work through this example yourself using the formulas on the previous pages. You can also plug these numbers into the SMART software and will get the same results.

Let's assume you want to move horizontally a mass of 6kg point-to-point over a distance of 100 mm (X) in 160 msec, including settling time (T_m) to +/- 1 micron. Total travel is 400mm, and a dwell time of 200msec is needed after each move.

Move Profile

We will assume an estimated settling time of 10msec (T_s).

The move cycle time (T_c) is 160 + 200 = 360msec

Using previous move formula:

$$T \text{ (msec)} = T_m - (T_s)$$

$$T \text{ (msec)} = 160 - 10 = 150\text{msec}$$

We will assume an efficient trapezoidal profile (1/3, 1/3, 1/3)

Acceleration needed here (see previous move formula):

$$A = 4.5 * (0.1 / 0.15^2)$$

$$A = 20\text{m/sec}^2 \text{ (about } 2 \text{ "g")}$$

$$V = (1.5) * (0.1 / 0.15)$$

$$V = 1\text{m/sec}$$

The acceleration and deceleration time becomes (150/3) = 50msec

The time at constant speed is (150/3) = 50msec

We can estimate the acceleration force of the load only (see previously mentioned formula) at $2 * 9.81 * 6\text{kg} = 117\text{N}$.

Based on this we can select S350T (peak force = 592N, continuous force = 148N) assuming a coil mounting plate of 1kg.

Total moving mass: 6kg (load) + 1kg (plate) + 1.9kg (coil mass) = 8.9kg

Coil resistance = 20.2ohm, Coil Force constant 99N/Ap, Thermal Resistance 2.4°C/W, Back Emf 33Vp/m/sec,

Inductance p-p 33mH, Electrical cycle length 120mm

We assume a good set of linear bearings with $\mu=0.005$ and 20N of friction.

Friction Force: $F_f \text{ (N)} = 8.9 * 9.81 * [\sin(0) + 0.005 * \cos(0)] + 20 = 20.4\text{N}$
 Inertial Force: $F_i \text{ (N)} = 8.9 * 20 = 178\text{N}$
 Total Acceleration Force: $F_1 \text{ (N)} = 178 + 20.4 = 198.4\text{N}$
 Total Constant Velocity Force: $F_2 \text{ (N)} = 20.4\text{N}$
 Total Deceleration Force: $F_3 \text{ (N)} = 178 - 20.4 = 157.6\text{N}$
 Total Dwell Force: $F_4 \text{ (N)} = 0\text{N}$
 RMS Force: $F_{rms} \text{ (N)} = \sqrt{[(198.4^2 * 0.05) + (20.4^2 * 0.05) + (157.6^2 * 0.05)] / 0.36}$
 $F_{rms} \text{ (N)} = 94.7\text{N}$
 RMS Current: $I_{ca} = 94.7 / 99 = 0.96 \text{ Amp rms}$
 Peak Current: $I_{pa} = 198.4 / 99 = 2 \text{ Amp rms}$
 Motor Resistance Hot: $R_{hot} = R * 1.423 = 20.2 * 1.423 = 28.7\Omega$
 Voltage due B EMF: $V_{bemf} = 33 * 1 = 33\text{Vac}$
 Voltage due I*R: $V_{ir} = 1.225 * 28.7 * 2 = 70.32\text{Vac}$
 Voltage due Inductance: $V_L = 7.695 * 1 * 33 * 2 / 120 = 4.23\text{Vac}$
 Bus Voltage needed: $V_{bus} = 1.15 * \sqrt{[(33 + 70.3)^2 + 4.23^2]} = 118.8\text{Vac}$

Item	Symbol	Value	Unit
Load Mass	M _L	7	kg
Load (Thrust) Force	F _L	0	N
Run (Pre-Load) Friction	F _r	20	N
Moving Motor Mass	M _c	1.9	kg
Friction Coefficient	μ	0.005	
Incline Angle	α	0	°
Available Voltage	V	120	Vac
Available Current	A	7	Arms
Max Allowable Temperature		110	°C

Item	Symbol	Value	Unit
Stroke	X	100	mm
Velocity	V	1	m/s
Acceleration Time	T _a	0.05	s
Constant velocity force	T _c	0.05	s
Deceleration Time	T _δ	0.05	s
Settling Time	T _σ	0.01	s
Waiting Time	T _w	0.2	s

About Nippon Pulse

Nippon Pulse is a global manufacturer and Tier 1 supplier of precision motion control products for original equipment manufacturers. We provide a wide array of motion control solutions to meet your needs. Our products include industry-leading stepper motors, the innovative Linear Shaft Motor, controllers and drivers. With several customization options, we can provide products that can be utilized in an extensive number of applications and can meet individual customer specifications.

Resources for Further Learning

More information is available on our website. Check out nipponpulse.com to check out user manuals and software files, as well as product-specific application notes and whitepapers. Video demos can be found on our YouTube channel.

Search Product Manual

Select a product category and subsection to see all available manuals.

Select a Product Category



Standards Compliance

All NPA and NPM branded products are RoHS compliant. Most of Nippon Pulse's other products are also RoHS compliant. We will work with you to ensure any of the products used in your application meet national and international compliance and certification standards.

Nippon Pulse America, Inc. is certified under ISO 9001:2015 and 14001:2015 for Quality and Environmental Management systems.

Sign Up For Our Quarterly E-newsletter!

Be the first to know about new products and features! Use your phone to scan the QR code:



Industries We Serve

Nippon Pulse serves original equipment manufacturers in the following industries:

- Automation
- Biomedical and Medical Equipment Manufacturing
- Instrumentation
- Machine Tooling
- Packaging
- Lab Automation
- Pharmaceutical
- Optics and Photonics
- Semiconductor

Follow Nippon Pulse America on social media:



twitter.com/nipponpulse



youtube.com/nipponpulseamerica



linkedin.com/company/nipponpulse



NPM

Worldwide

Nippon Pulse Group has subsidiary offices, sales offices, affiliates and production factories in several locations across Asia, including Japan, China, Korea, Taiwan and the Philippines. Nippon Pulse America, Inc.'s sales office is in Virginia, and NPA has representatives and distributors across North America and Europe.



NPM
Nippon Pulse
Motor Co., Ltd.

Head Office
Tokyo, Japan



NPA
Nippon Pulse
America, Inc.

Sales Office
Radford, Virginia

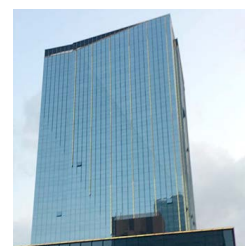

NPH
Nippon Pulse
Hong Kong, Ltd.

Managing Office
Hong Kong

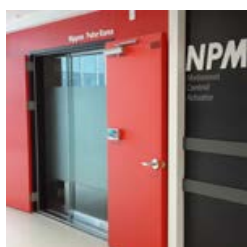

NPMK
Nippon Pulse
Korea Co., Ltd.

Sales Office
South Korea

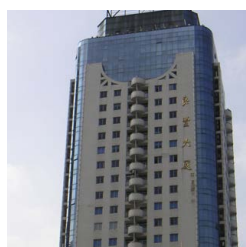

NPMS
Nippon Pulse
Shanghai Co., Ltd.

Sales Office
Shanghai, China



NPM-HT
NPM High
Technologies Co.,
Ltd.

Sales Office
Tokyo, Japan



NPAT
Nippon Pulse Asia
Trading Ltd.

Sales Office
Taiwan (R.O.C.)



NPMT-WH
Nippon Pulse
Motor Trading
(Wuhan) Co. Ltd.

Sales Office
Hubei, China



NPC
Pulse Electronics
Co. Ltd.

Production
Guangdong
Province, China



NPTEC
Nippon Pulse Tec
Philippines Inc.

Production
Philippines

Sales Contact:

NPM

Nippon Pulse America, Inc.
4 Corporate Drive
Radford, VA 24141

1-540-633-1677
info@nipponpulse.com
nipponpulse.com

N I P P O N P U L S E . C O M